

WALLED LAKE

CITY OF NOVI, CITY OF WALLED LAKE
OAKLAND COUNTY
MICHIGAN

WATER QUALITY TESTING
2014

Prepared by:
Savin Lake Services
3088 Hottis Road
Hale, MI 48739

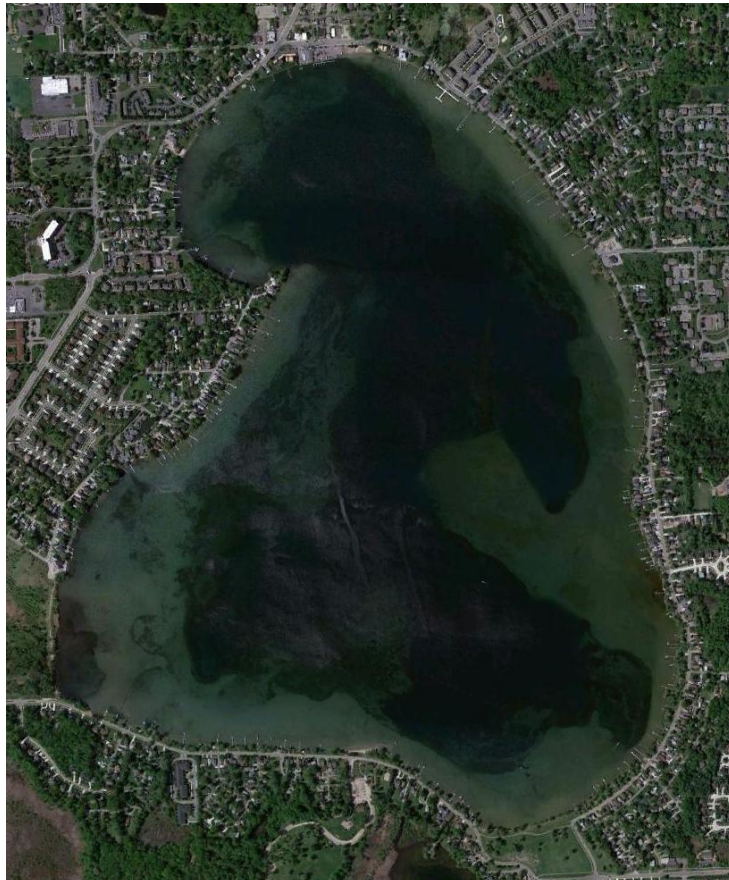



Walled Lake

Walled Lake is a 652-acre moderately hard-water lake, located in Sections 34 and 35 of the City of Walled Lake (T2N R8E), and in Sections 2 and 3 of the City of Novi (T1N R8E), Oakland County, MI. The lake has a maximum depth of approximately 50 feet and contains 8060 acre-feet of water. The length of the shoreline is 24,200 feet.

The lake has one inlet which leads from Mud Lake into Walled Lake on its south end, near the park. There is an outlet named Beaver Creek which exits Walled Lake on the Southwest corner near the undeveloped portion of shoreline.

The size of the watershed which includes all the lands that contribute water to the lake, but does not include the lake, is about 1,933 acres. The drainage area, which includes the watershed and the lake, is about 2585 acres. The watershed to lake ratio is about 2.96 to 1.

THE WATER QUALITY STUDY

During certain periods, Michigan lakes have poorer water quality than the rest of the year. Usually our studies involve sampling the lake in early spring when phosphorus from the bottom sediments may be mixed into the water column causing early spring algal blooms; and late summer when the water is warmest, and the lake is stratified (if it stratifies). Thus, if the lake gets high marks for water quality during early spring and late summer it probably has pretty good water quality all year.

This study looked at the 2014 spring and late summer sampling periods.



THE SAMPLE STATIONS

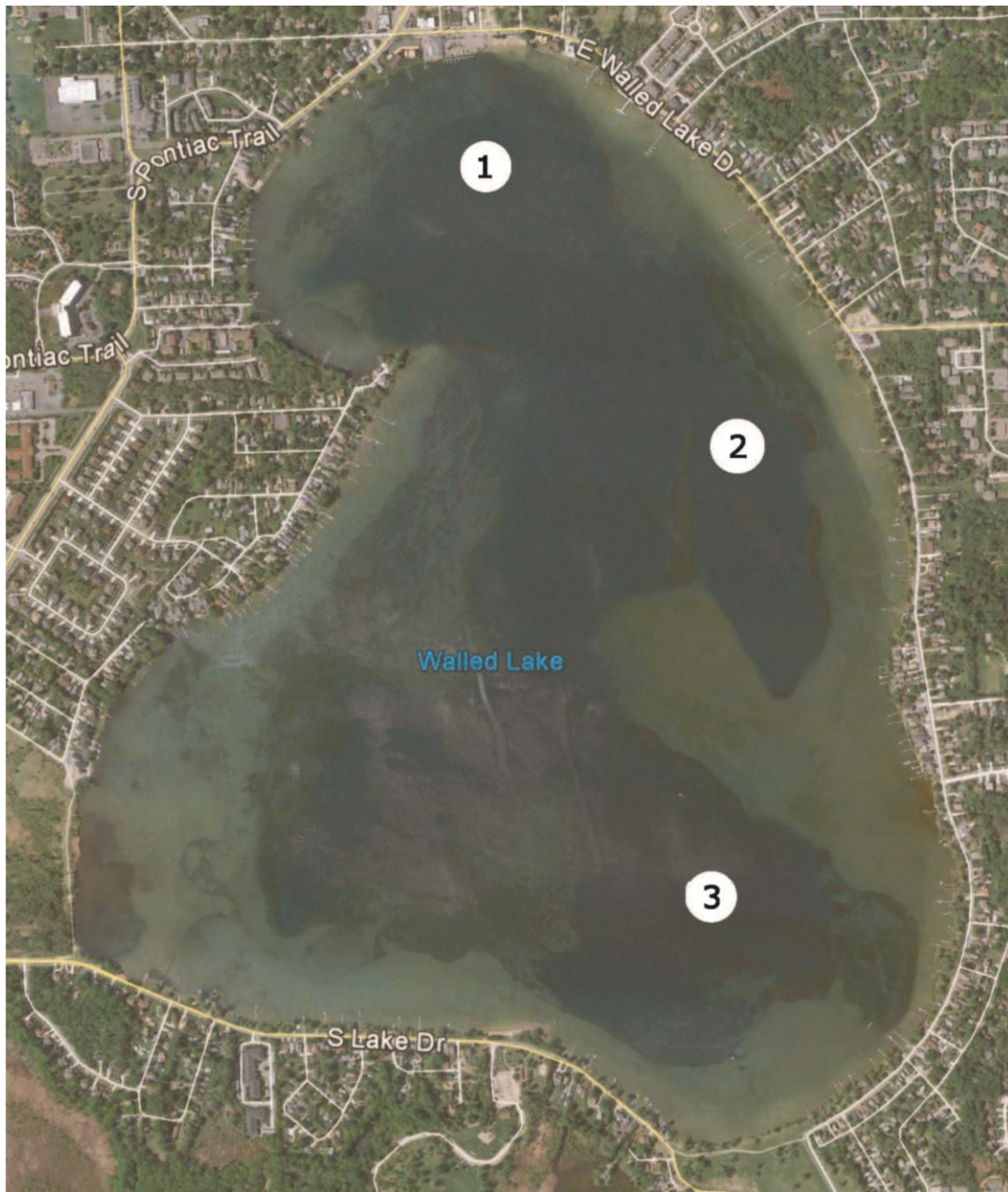

The locations of the three in-lake sample stations are shown as circles on the map of the lake. Site 2 is at the deepest part of the lake.

SAMPLE DATES

Savin Lake Services personnel collected three surface samples at the stations shown on the map on June 5th, 2014 and September 21st, 2014. Top to bottom temperature and dissolved oxygen profile data were also collected at Station 2.

THE ANALYSES

Dissolved oxygen, temperature, pH and Secchi disk transparency measurements were conducted in the field. Total phosphorus, conductivity, alkalinity, total nitrate, and chlorophyll α analysis was completed at an independent laboratory.

THE DATA

The data discussed below are found in the table at the end of this report.

TEMPERATURE AND DISSOLVED OXYGEN

Temperature exerts a wide variety of influences on most lakes, such as the separation of layers of water (stratification), solubility of gases, and biological activity.

Dissolved oxygen is the parameter most often selected by lake water quality scientists as being important. Besides providing oxygen for aquatic organisms in natural lakes, dissolved oxygen is involved in phenomena such as phosphorus precipitation to, and release from, the lake bottom sediments and decomposition of organic material in the lake.



2014

The dissolved oxygen concentrations were only slightly low for the temperature of the water. The thermocline developed at 36 feet, and continued to the bottom of the lake. The dissolved oxygen drastically decreased at the start of the thermocline, lowering from 8.27 mg/L at 36 feet to 0.34 mg/L at 38 feet. There, it remained near 0 mg/L to the bottom of the lake.

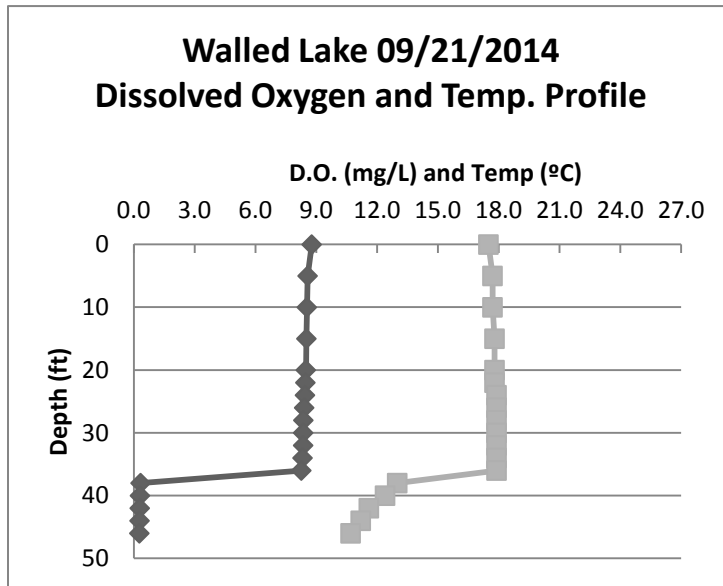

Temp (°C)	D.O. (mg/L)	Depth (ft)
17.5	8.78	0
17.7	8.58	5
17.7	8.54	10
17.8	8.52	15
17.8	8.49	20
17.8	8.47	22
17.9	8.45	24
17.9	8.41	26
17.9	8.37	28
17.9	8.36	30
17.9	8.36	32
17.9	8.33	34
17.9	8.27	36
13	0.34	38
12.4	0.31	40
11.6	0.30	42
11.2	0.29	44
10.7	0.28	46

Low dissolved oxygen concentrations (below 4 milligrams per liter) are generally insufficient to support fish life. In most Michigan lakes, there is no dissolved oxygen below the thermocline in late summer. Some experts like to see some dissolved oxygen in the bottom water of a lake, even if it is almost zero. This is because as long as there is some dissolved oxygen in the water at the bottom of the lake, phosphorus precipitated by iron to the bottom sediments will remain there. Once a lake runs out of dissolved oxygen in the water at the bottom iron comes back into solution. When that happens, it releases the phosphorus back into the water. This can cause additional algae to grow when the lake mixes.

DISSOLVED OXYGEN, PERCENT SATURATION

There were no readings available during the spring. The instrumentation used for this readings malfunctioned during the sampling. However during the late summer, the percentages ranged from 85 to 93 percent. Although this is slightly lower than optimal, it is still ok.

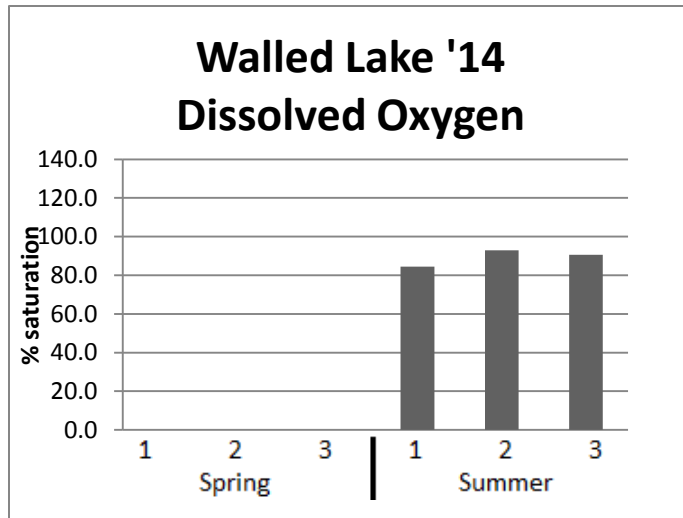

Because the amount of dissolved oxygen a water can hold is temperature dependent with cold water holding more than warm water, dissolved oxygen saturation is often a better way to determine if oxygen supplies are adequate. The best is between 90 and 110 percent.

CHLOROPHYLL A

Chlorophyll a is used by lake scientists as a measure of the biological productivity of the water. Generally, the lower the chlorophyll a, the better. High concentrations of chlorophyll a are indicative of an algal bloom in the lake, an indication of poor lake water quality. The highest surface chlorophyll a concentration found by Wallace Fusilier (Water Quality Investigators, WQI) in a Michigan lake was 216 micrograms per liter. Best is below one microgram per liter.

Walled Lake's chlorophyll a values are overall excellent. There were only 2 spring results available, as site 2's sample was destroyed at the laboratory. The other two values for spring were 1.0 and 0.7 ug/L. The summer values were 1.1, 1.3, and 1.0 ug/L. Again, these are great results.

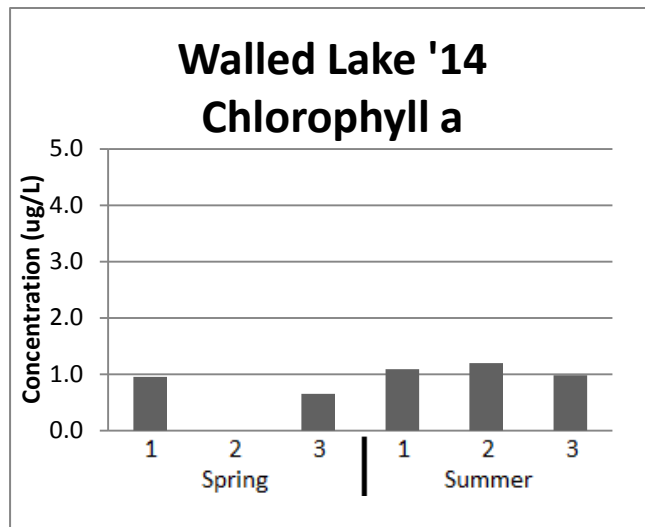

SECCHI DISK TRANSPARENCY (originally Secchi's disk)

In 1865, Angelo Secchi, the Pope's astronomer in Rome, Italy devised a 20-centimeter (8 inch) white disk for studying the transparency of the water in the Mediterranean Sea. Later an American limnologist (lake scientist) named Whipple divided the disk into black and white quadrants which many are familiar with today.

The Secchi disk transparency is a lake test widely used and accepted by limnologists. The experts generally felt the greater the Secchi disk depth, the better quality the water. However, one Canadian scientist pointed out acid lakes have very deep Secchi disk readings. (Would you consider a very clear lake a good quality lake, even if it had no fish in it? It would be almost like a swimming pool.) Most lakes in southeast Michigan have Secchi disk transparencies of less than ten feet. On the other hand, Elizabeth Lake in Oakland County had 34 foot Secchi disk readings in summer 1996, evidently caused by a zebra mussel invasion a couple of years earlier.

Most limnology texts recommend the following: to take a Secchi disk transparency reading, lower the disk into the water on the shaded side of an anchored boat to a point where it disappears. Then raise it to a point where it's visible. The average of these two readings is the Secchi disk transparency depth.



Secchi disk measurements should be taken between 10 AM and 4 PM. Rough water will give slightly shallower readings than smooth water. Sunny days will give slightly deeper readings than cloudy days. However, roughness influences the visibility of the disk more than sunny or cloudy days.

SECCHI DISK DATA

The spring values for secchi disk readings in 2014 ranged from 15.0 to 18.5 feet. In the summer, they were 15.0 to 17.0 feet in both spring and summer. These are ok values for the depth of the lake. Deeper would be better.

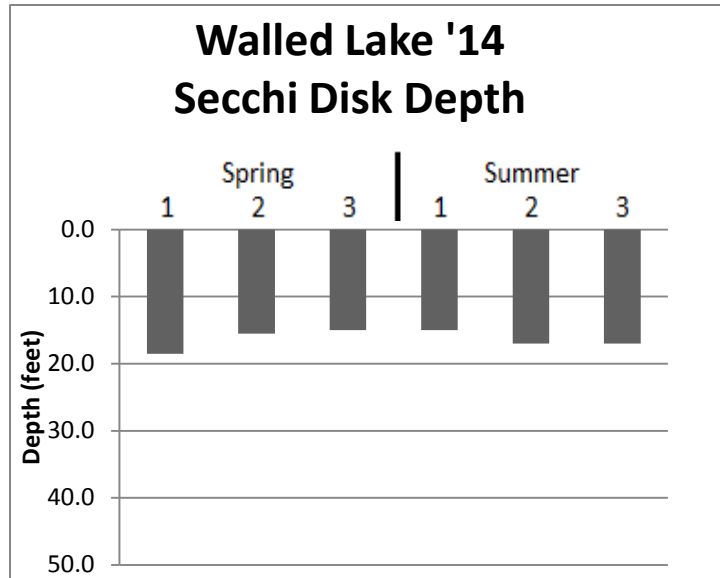

TOTAL PHOSPHORUS

Although there are several forms of phosphorus found in lakes, the experts selected total phosphorus as being most important. This is probably because all forms of phosphorus can be converted to the other forms. Currently, most lake scientists feel phosphorus, which is measured in parts per billion (1 part per billion is one second in 31 years) or micrograms per liter (ug/L), is the one nutrient which might be controlled. If its addition to lake water could be limited, the lake might not become covered with the algal communities so often found in eutrophic lakes.

Based on WQI's studies of many Michigan inland lakes, they've found many lakes were phosphorus limited in spring (so don't add phosphorus) and nitrate limited in summer (so don't add nitrogen).



10 parts per billion is considered a low concentration of phosphorus in a lake and 50 parts per billion is considered a high value in a lake by many limnologists.

The graph shows Walled Lake's total phosphorus concentrations ranged from 10.5 to 10.9 micrograms per liter in the spring. These are great values. The late summer samples however were significantly higher, being 30, 40, and 40 micrograms per liter. These values are fairly high and should be monitored by future samplings to determine if these high values are recurring.

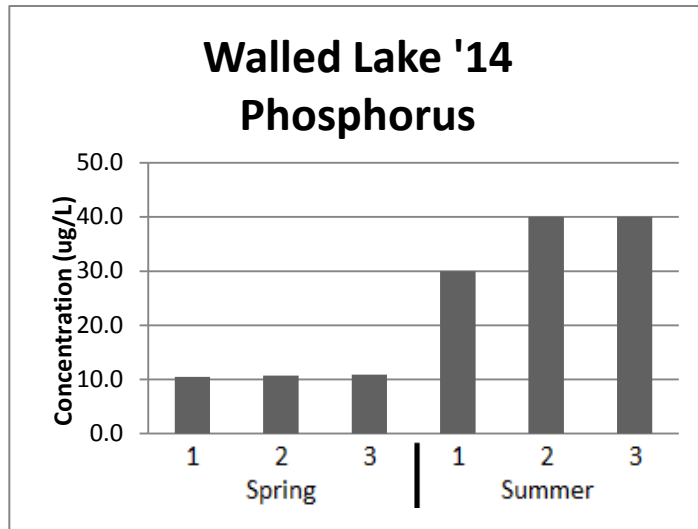

NITRATE NITROGEN

Nitrate, also measured in the parts per billion range, has traditionally been considered by lake scientists to also be a limiting nutrient. The experts felt any concentration below 200 parts per billion was excellent in terms of lake water quality. The highest value found by Fusilier was 48,000 parts per billion in an Ottawa County river which flowed into Lake Macatawa in Holland, Michigan

On the other hand, WQI has studied hundreds of Michigan inland lakes, and many times we find them nitrate limited (very low nitrate nitrogen concentrations), especially in summer.

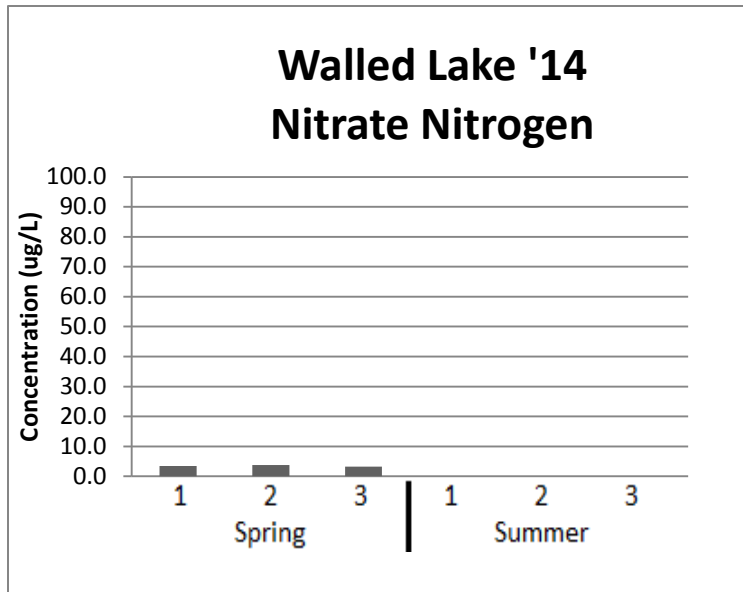

Spring 2014 values were 3.4, 3.7, and 3.2 ug/L. These are great values. In the summer the detection limits were not set correctly by the laboratory. Therefore, all we know is that the values were all below 100 ug/L for all 3 sites. However despite this, anything under 100 ug/L is still a great value. Lower

summer values are typical in a Michigan inland lake.

Generally limnologists feel optimal nitrate nitrogen concentrations (which encourage maximum plant and algal growth) are about 10-20 times higher than phosphorus concentrations. The reason more nitrogen than phosphorus is needed is because nitrogen is one of the chemicals used in the production of plant proteins, while phosphorus is used in the transfer of energy, but is not used to create plant material. If the nitrate concentration is less than 10-20 times the phosphorus concentration, the lake is considered nitrogen limited. If the nitrate concentration is higher than 10-20 times the phosphorus concentration, the lake is considered phosphorus limited.

TOTAL ALKALINITY

Alkalinity is a measure of the ability of the water to absorb acids (or bases) without changing the hydrogen ion concentration (pH). It is, in effect, a chemical sponge. In most Michigan lakes, alkalinity is due to the presence of carbonates and bicarbonates which were introduced into the lake from ground water or streams which flow into the lake. In lower Michigan, acidification of most lakes should not be a problem because of the high alkalinity concentrations.

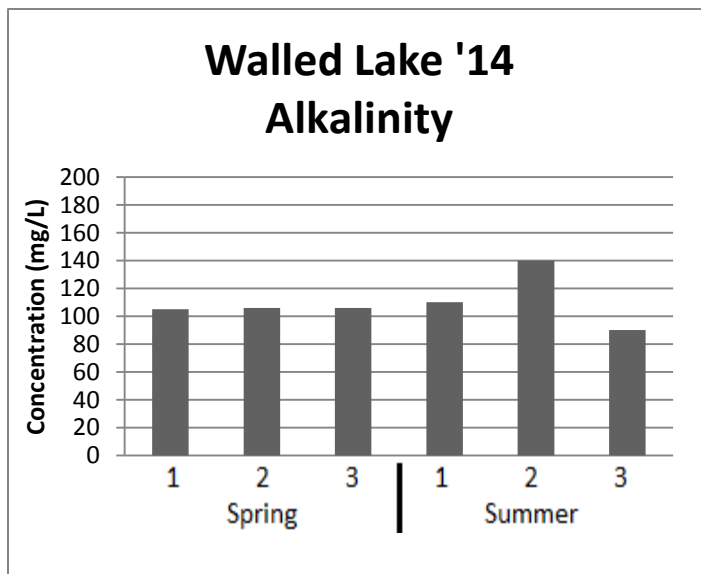

Walled Lake's surface alkalinity data (90-140 milligrams per liter) indicates it is a moderately hard to hard water lake, which is good. This is because hard water lakes have the ability to precipitate some of the phosphorus that enters the lake to the bottom sediments as calcium phosphate. This pretty much ties up that

phosphorus in the sediments. Soft water lakes lack this ability.

HYDROGEN ION CONCENTRATION (pH)

pH has traditionally been a measure of water quality. Today it is an excellent indicator of the effects of acid rain on lakes. About 99% of

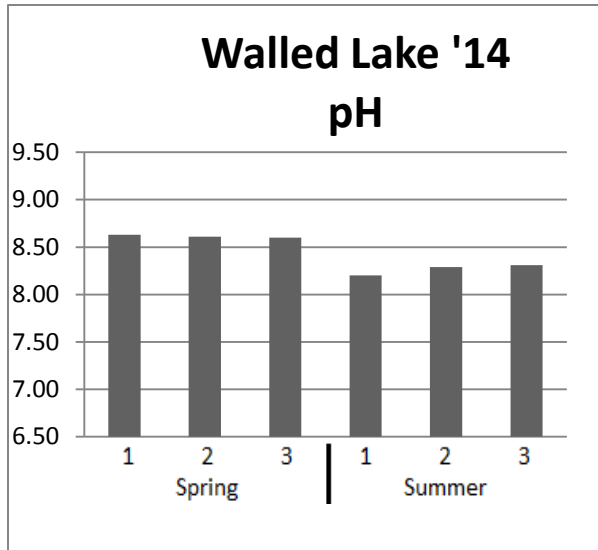

the rain events in southeastern Michigan are below a pH of 5.6 and are thus considered acid. However, there seems to be no lakes in Michigan which are being affected by acid rain. Most lakes have pH values between 7.5 and 9.0.

Walled Lake's pH values (8.20 to 8.63) are within the normal range for a hard water Michigan inland lake.

SPECIFIC CONDUCTIVITY

Conductivity, measured with a meter, detects the capacity of a water to conduct an electric current. More importantly however, it measures the amount of materials dissolved in the water (salts), since only dissolved materials will permit an electric current to flow. Theoretically, pure water will not conduct an electric current. It is the

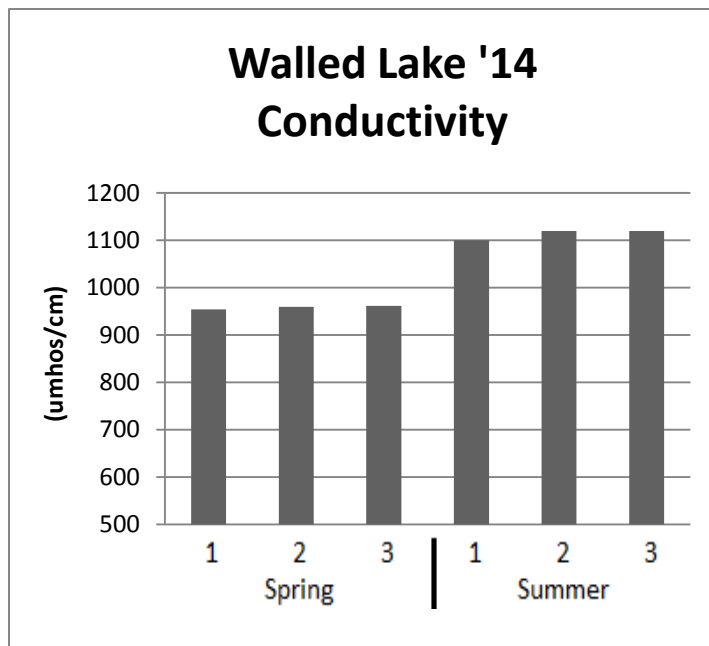

perception of the experts that poor quality water has more dissolved materials than does good quality water.

The graph shows Walled Lake's conductivities range from 954 to 962 micromhos per centimeter in the spring and 1100 to 1120 in the summer. These are very high numbers for a hard water Michigan inland lake. One possible reason may be because of the use of road salt during the winter. Most lakes Savin Lake Services samples has values between 200 to 400.

THE LAKE WATER QUALITY INDEX

The Lake Water Quality Index (LWQI) (Fusilier, 1982) used in this study to define the water quality of Walled Lake was developed for two reasons. First, there was no agreement among lake scientists regarding which tests should be used to define the water quality of a lake; and second, there was no agreement among lake scientists regarding the meaning of the data collected during lake studies.

Development of the index involved two questionnaires which were sent to a panel of 555 scientists who were members of the American Society of Limnology and Oceanography. The panel was specifically selected because they were chemists and biologists with advanced degrees who studied lake water quality.

The first questionnaire asked the scientists to select tests which they felt should be used to define lake water quality.

The tests most often selected by the scientists became the index parameters (or tests). They were:

Dissolved oxygen (Percent saturation)
Total alkalinity
Chlorophyll a
Secchi disk depth
Total nitrate nitrogen

Total phosphorus
pH
Temperature
Conductivity

The second questionnaire, sent out after the first was returned, asked the scientists what the results of the tests they selected as good indicators of lake water quality meant.



After the responses to the second questionnaire were tabulated, the nine tests and the accompanying rating curves were combined into a Lake Water Quality Index.

The index ranges from 1 to 100, with 100 indicating excellent lake water quality. The index rated lakes about the same way teachers rate students: 90-100=A, 80-90=B, 70-80=C, 60-70=D, and below 60=E.

The highest index for a Michigan lake studied by Fusilier was Long Lake in Grand Traverse County at 100 in the spring of 1994. The lowest was 16 in an Ottawa County lake.

WALLED LAKE 2012 LAKE WATER QUALITY INDICES

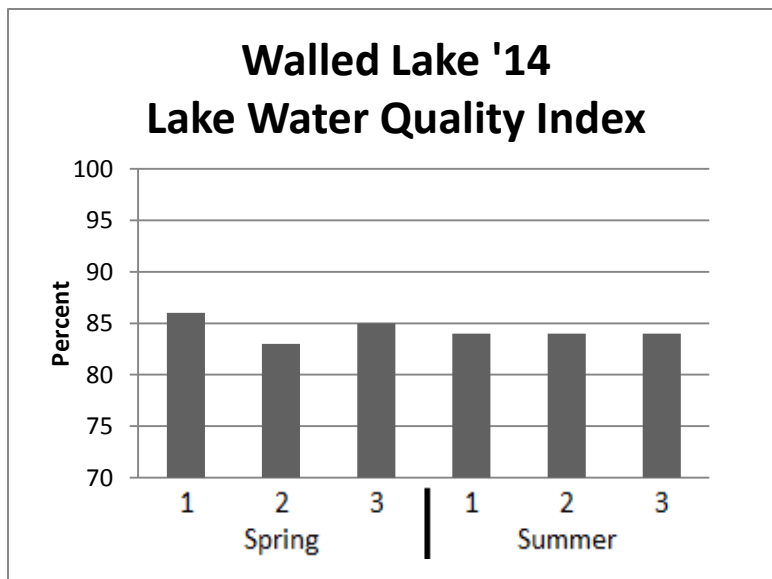

The graph shows the water quality of Walled Lake in the spring were 86, 83, and 85 for each respective site; and 84 for all sites in the summer. All sites received a B in 2014.



THE LAKE WATER QUALITY INDEX CALCULATION SHEETS

The Lake Water Quality Index calculation sheets were developed to show graphically what the results of the nine different lake water quality tests meant in terms of lake water quality.

HOW TO READ THE LAKE WATER QUALITY INDEX CALCULATION SHEETS

Listed across the top of the calculation sheets are the tests selected by the panel of experts as being good indicators of lake water quality.

The figures which look like thermometers are graphs which convert the test results (the values found on the outside of the thermometer) to a uniform 0-100 lake water quality rating (found on the inside of the thermometer).

The calculation sheet combines all nine of the individual quality ratings into a single Lake Water Quality Index. The index ranges from 1 (very poor lake water quality) to 100 (excellent lake water quality). The index is portrayed in three different ways: as a number ranging between 1 and 100 in the circle marked LWQI, and by a color and position on the sheet edge scale. The purpose of the sheet-edge scale is to review quickly large numbers of lakes or sample sites within a lake and determine how the quality of the various lakes or sites compare.

The position of the lines on the thermometer rating scales permits determination of the parameter (or parameters) which cause the index to be depressed. The lower the line, the greater the problem. A glance at the top of the problem rating scale identifies the test and the test results. The rating scales also permit determination of what test results would be considered excellent in terms of lake water quality by the panel of experts surveyed. They are the numbers on the outside the thermometers, near the top.



WALLED LAKE WATER QUALITY INDICES CALCULATION SHEETS

Four water quality index calculation sheets are included in this report. Three of the four are from each sample site for the sampling date. The other one is an averaged sheets for the sampling date.

Matthew Novotny
 Geochemist
 Savin Lake Services
 Hale, Michigan
 February, 2015

Walled Lake Water Quality Data

Date	Sample Station Number	Temperature (°C)	Dissolved Oxygen		Chlorophyll α (ug/L)	Secchi Disk Depth (ft)	Total Nitrate Nitrogen (ug/L)	Alkalinity (mg/L)	pH	Conductivity umhos per cm at 25 °C	Total Phosphorus (ug/L)	Lake Water Quality Index	Grade
			(mg/L)	Percent Saturation									
6/5/2014	1	22.8	N/A	N/A	1.0	18.5	3.4	105	8.63	954	10.5	86	B
6/5/2014	2	22.2	N/A	N/A	N/A	15.5	3.7	106	8.61	960	10.7	83	B
6/5/2014	3	22.1	N/A	N/A	0.7	15.0	3.2	106	8.60	962	10.9	85	B
9/21/2014	1	17.7	7.99	84.6	1.1	15.0	<100	110	8.20	1100	30.0	84	B
9/21/2014	2	17.5	8.78	92.9	1.2	17.0	<100	140	8.29	1120	40.0	84	B
9/21/2014	3	17.3	8.74	90.6	1.0	17.0	<100	90	8.31	1120	40.0	84	B

Wallace E. Fusilier, Ph.D. is a highly regarded consulting limnologist. Information and styling found within this report are the result of Fusilier's dedication and professionalism as a limnologist.



CALCULATION SHEET FOR THE UNWEIGHTED MULTIPLICATIVE LAKE WATER QUALITY INDEX

Temperature in degrees C: **22.8**
 Dissolved Oxygen, % Saturation: **N/A**
 Chlorophylla ug/L: **1.0**
 Secchi Disk Depth in feet: **18.5**
 Nitrate-N ug/L: **3.4**
 Alkalinity in g/L: **105**
 pH S.U.: **8.63**
 Specific Conductivity umhos/cm @ 25C: **954**
 Total Phosphorus ug/L: **10.5**

Oakland County
 City of Novi
 Walled Lake Township
 Savin Analyst
 50 feet Lake Depth
 652 Acres Lake Area

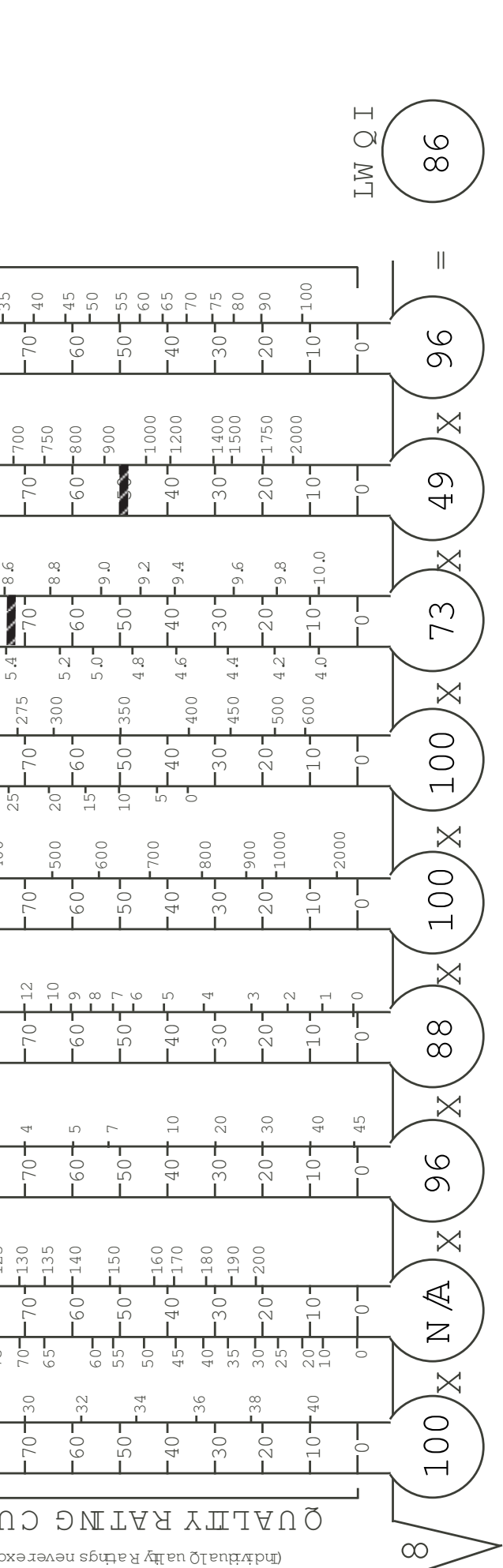

SET THE PARAMETER QUALITY RATING AT 1 IF THE EXTREMAL EXTREME VALUE RANGE IS EXCEEDED



DATE: 06/05/2014
 STATION: 1
 LAKE: Walled Lake

CALCULATION SHEET FOR THE UNWEIGHTED MULTIPLICATIVE LAKE WATER QUALITY INDEX

Temperature in degrees C: 22.2
 Dissolved Oxygen, % Saturation: N/A
 Chlorophylla ug/L: N/A
 Secchi Disk Depth in feet: 15.5
 Nitrate-N ug/L: 3.7
 Alkalinity in g/L: 106
 pH S.U.: 8.61
 Specific Conductivity umhos/cm @ 25C: 960
 Total Phosphorus ug/L: 10.7

County: Oakland
 City of Novato: Walled Lake
 Township:
 Savin Analyst
 50 feet
 Lake Depth
 652 Acres
 Lake Area

W. Fustler, Ph.D.
 (Individual quality Ratings never exceeded 100)

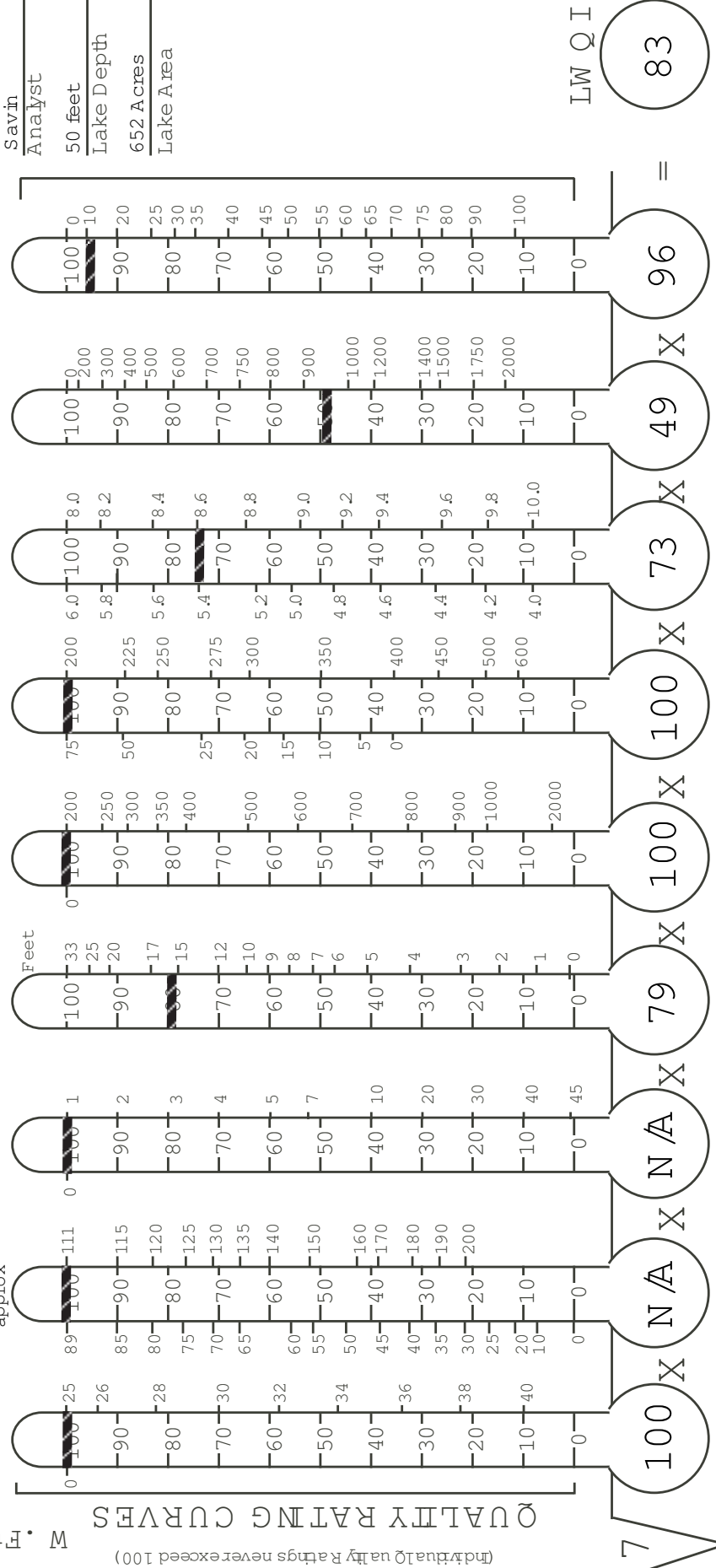

SET THE PARAMETER QUALITY RATING AT 1 IF THE EXTERNAL EXTREME VALUE RANGE IS EXCEEDED



CALCULATION SHEET FOR THE UNWEIGHTED MULTIPLICATIVE LAKE WATER QUALITY INDEX

W. Fustler, Ph.D.

Temperature in degrees C: **22.1**
 Dissolved Oxygen, % Saturation: **N/A**
 Chlorophylla ug/L: **0.7**
 Secchi Disk Depth in feet: **15.0**
 Nitrate-N ug/L: **3.2**
 Alkalinity in g/L: **106**
 pH S.U.: **8.60**
 Specific Conductivity umhos/cm @ 25C: **962**
 Total Phosphorus ug/L: **10.9**

County: Oakland
 City of Novia: Walled Lake
 Township: Walled Lake
 Savin Analyst: Walled Lake
 50 feet Lake Depth: Walled Lake
 652 Acres Lake Area: Walled Lake

QUALITY RATING CURVES

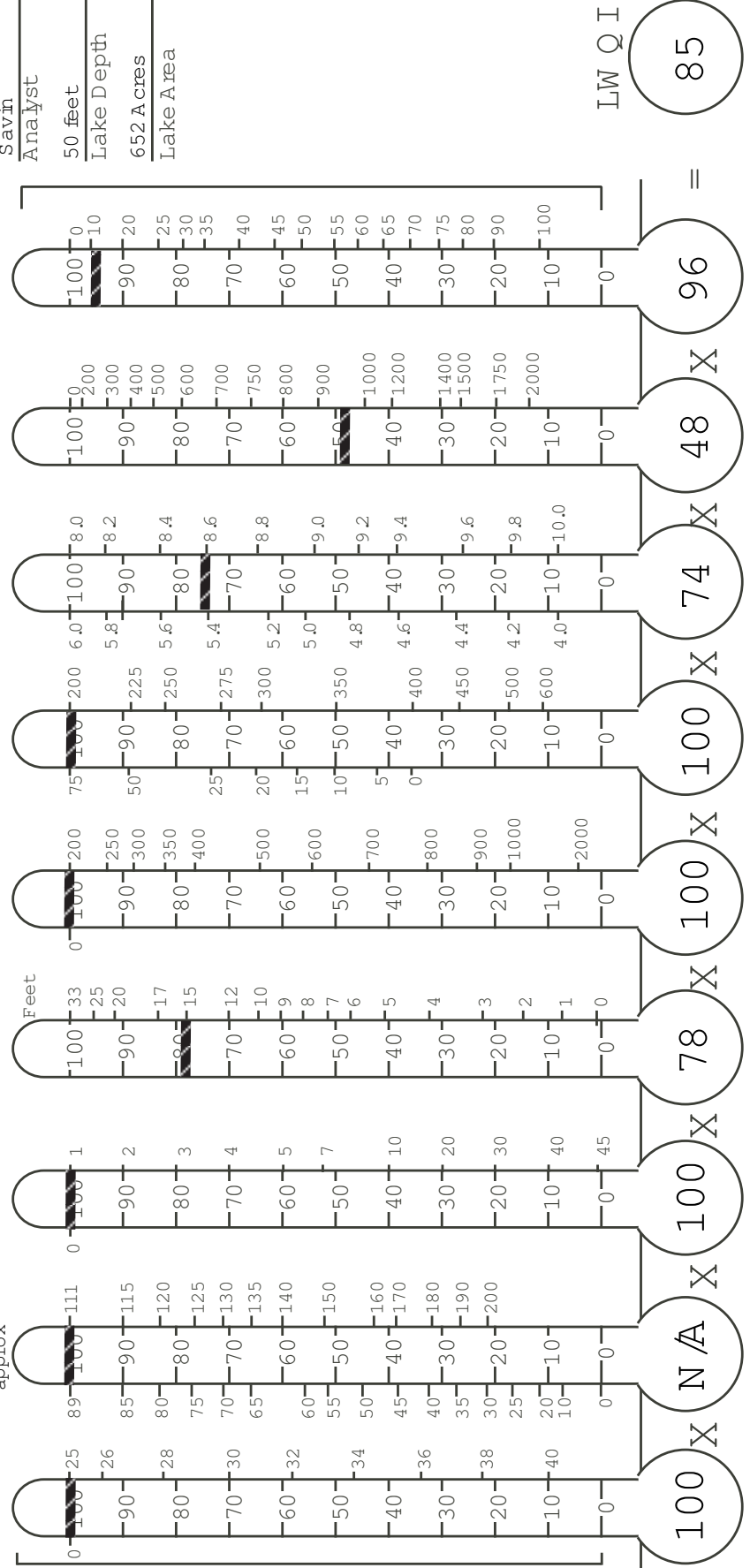

SET THE PARAMETER QUALITY RATING AT 1 IF THE EXTERNAL EXTREME VALUE RANGE IS EXCEEDED

DATE: 06/05/2014
 STATION: 3
 LAKE: Walled Lake



CALCULATION SHEET FOR THE UNWEIGHTED MULTIPLICATIVE LAKE WATER QUALITY INDEX

W. Fustler, Ph.D. (Individual Quality Ratings never exceeded 100)

Temperature in degrees C: **22.4**

Dissolved Oxygen, % Saturation: **N/A**

Chlorophylla ug/L: **0.8**

Secchi Disk Depth in feet: **16.3**

Nitrate-N ug/L: **3.4**

Alkalinity in g/L: **106**

pH S.U.: **8.61**

Specific Conductivity umhos/cm @ 25C: **959**

Total Phosphorus ug/L: **10.7**

Oakland County

City of Novi/Walled Lake Township

Savin Analyst

50 feet Lake Depth

652 Acres Lake Area

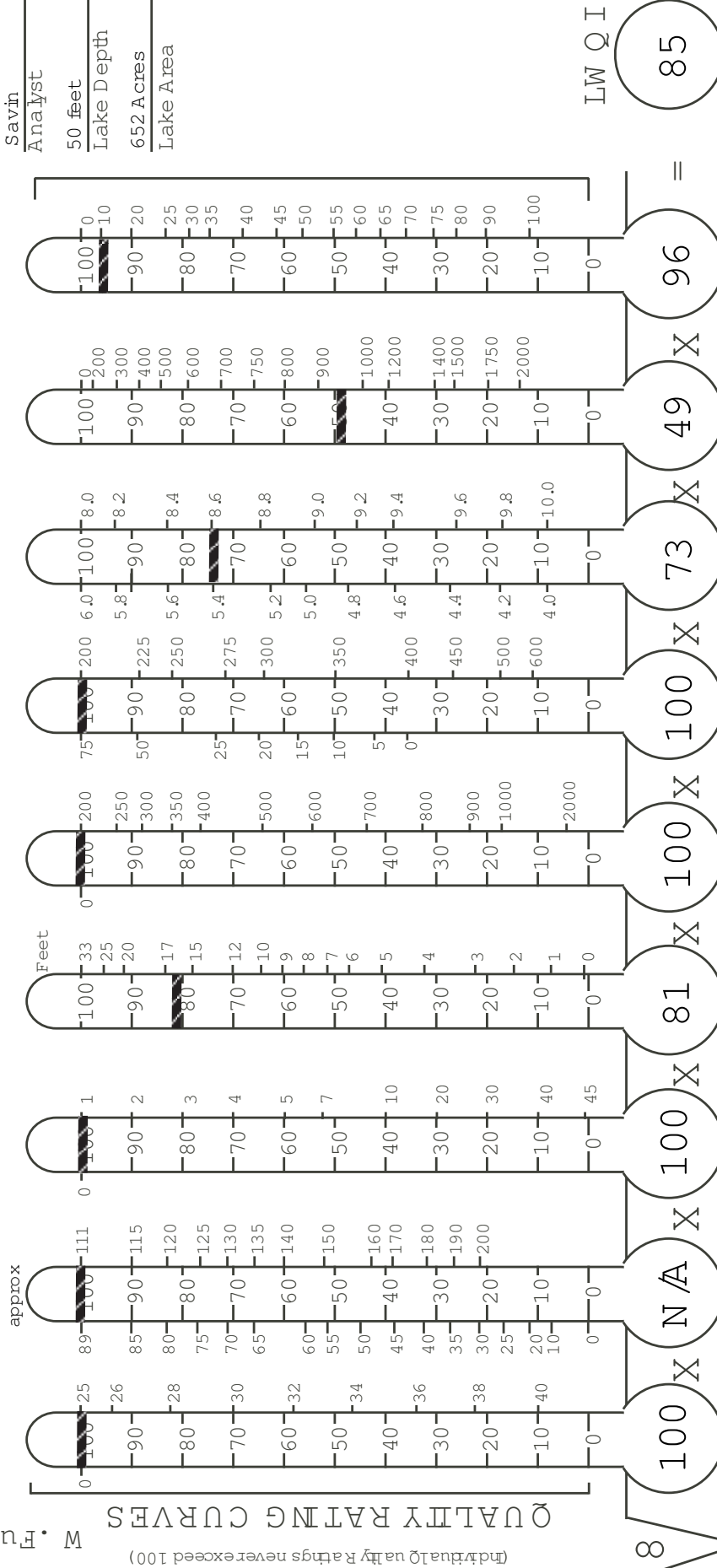

SET THE PARAMETER QUALITY RATING AT 1 IF THE EXTREMELY LOW VALUE RANGE IS EXCEEDED

DATE: 06/05/2014

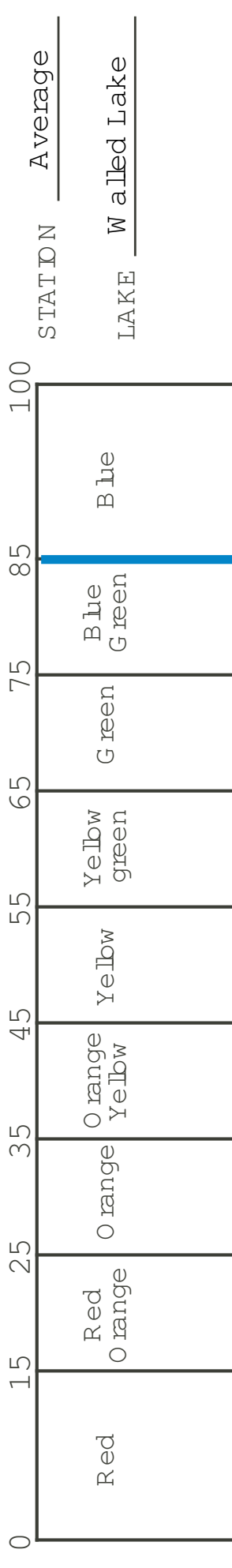

STATION: Average

LAKE: Walled Lake

CALCULATION SHEET FOR THE UNWEIGHTED MULTIPLICATIVE LAKE WATER QUALITY INDEX

Temperature in degrees C **17.7** Dissolved Oxygen, % Saturation **8.0 / 9.5** Chlrophylla ug/L **1.1** Secchi Disk Depth in feet **15.0** Nitrate-N ug/L **<100** Alkalinity in g/L **110** pH S.U. **8.20** Specific Conductivity umhos/cm @ 25C **1100** Total Phosphorus ug/L **30**

County **Oakland** City of Novich **Walled Lake** Township **Walled Lake** Savin Analyst **Savin** 50 feet Lake Depth **50** 652 Acres Lake Area **652**

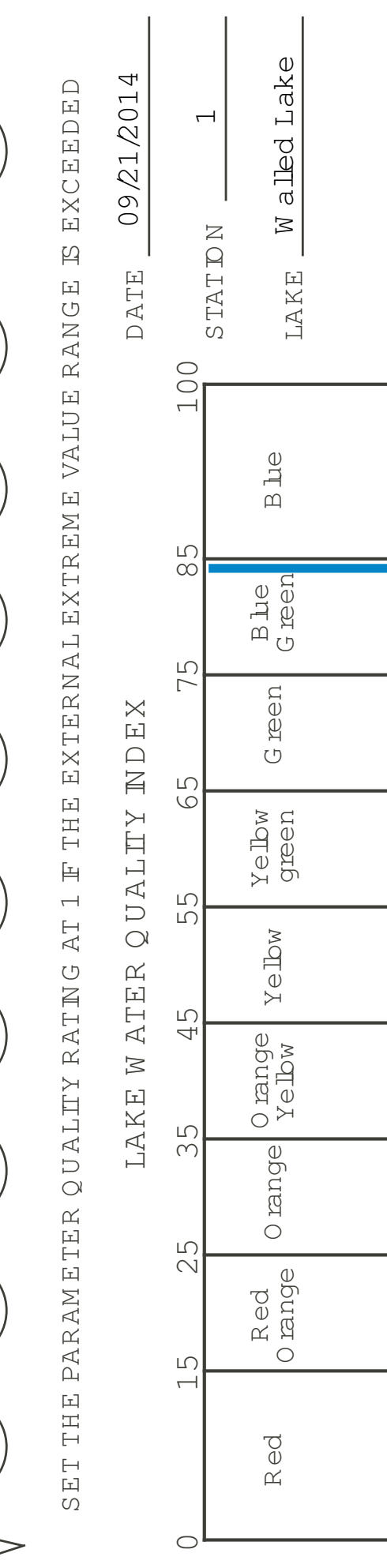
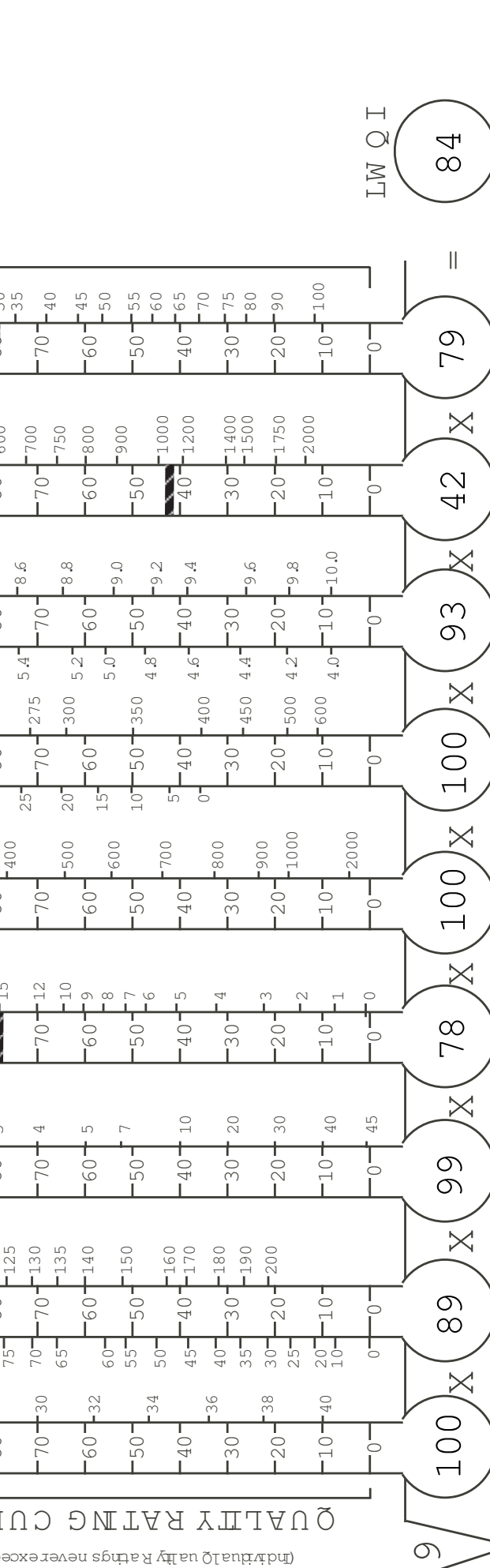

SET THE PARAMETER QUALITY RATING AT 1 IF THE EXTERNAL EXTREME VALUE RANGE IS EXCEEDED

DATE **09/21/2014** STATION **1** LAKE **Walled Lake**

CALCULATION SHEET FOR THE UNWEIGHTED MULTIPLICATIVE LAKE WATER QUALITY INDEX

Temperature in degrees C **17.5** Dissolved Oxygen, % Saturation **8.8 / 9.5** Chlrophylla ug/L **1.2** Secchi Disk Depth in feet **17.0** Nitrate-N ug/L **<100** Alkalinity in g/L **140** pH S.U. **8.29** Specific Conductivity umhos/cm @ 25C **1120** Total Phosphorus ug/L **40**

County Oakland City of Novia Walled Lake Township Savin Analyst 50 feet Lake Depth 652 Acres Lake Area

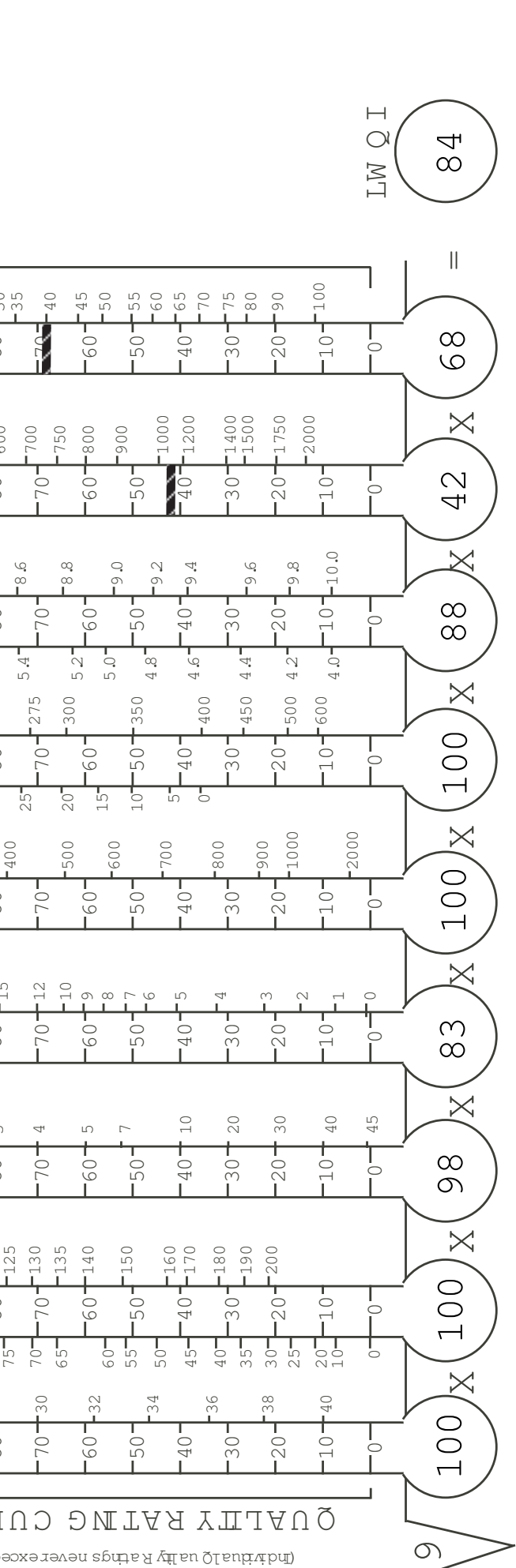

SET THE PARAMETER QUALITY RATING AT 1 IF THE EXTREMAL EXTREME VALUE RANGE IS EXCEEDED

LAKE WATER QUALITY INDEX

DATE 09/21/2014 STATION 2

LAKE Walled Lake

W. Fustler, Ph.D. (Individual quality Ratings never exceeded 100)

CALCULATION SHEET FOR THE UNWEIGHTED MULTIPLICATIVE LAKE WATER QUALITY INDEX

W. Fustler, Ph.D.

Temperature in degrees C	17.3	Dissolved Oxygen, % Saturation	8.7 / 9.7 90.6	Chlorophylla ug/L	1.0	Secchi Disk Depth in feet	17.0	Nitrate-N ug/L	<100	Alkalinity in g/L	90	pH S.U.	8.31	Specific Conductivity umhos/cm @ 25C	1120	Total Phosphorus ug/L	40
--------------------------	------	--------------------------------	-------------------	-------------------	-----	---------------------------	------	----------------	------	-------------------	----	---------	------	--------------------------------------	------	-----------------------	----

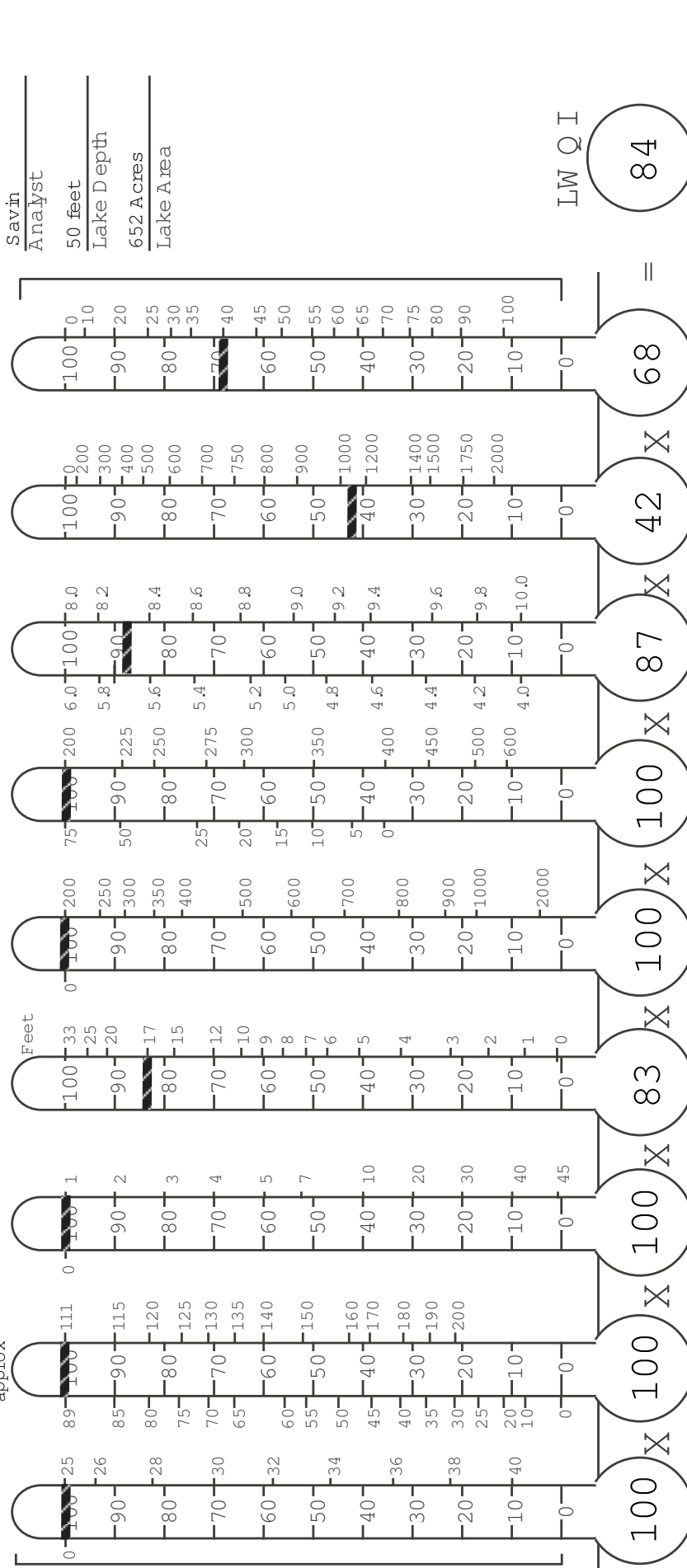

SET THE PARAMETER QUALITY RATING AT 1 IF THE EXTERNAL EXTREME VALUE RANGE IS EXCEEDED

DATE	09/21/2014
STATION	3
LAKE	Walled Lake



CALCULATION SHEET FOR THE UNWEIGHTED MULTIPLICATIVE LAKE WATER QUALITY INDEX

Temperature in degrees C: 17.5
 Dissolved Oxygen, % Saturation: 8.5 / 9.5 = 90.0
 Chlorophylla ug/L: 1.1
 Secchi Disk Depth in feet: 16.3
 Nitrate-N ug/L: <100
 Alkalinity in g/L: 113
 pH S.U.: 8.27
 Specific Conductivity umhos/cm @ 25C: 1113
 Total Phosphorus ug/L: 36.7

County: Oakland
 City of Novi: Walled Lake
 Township:
 Savin Analyst
 50 feet Lake Depth
 652 Acres Lake Area

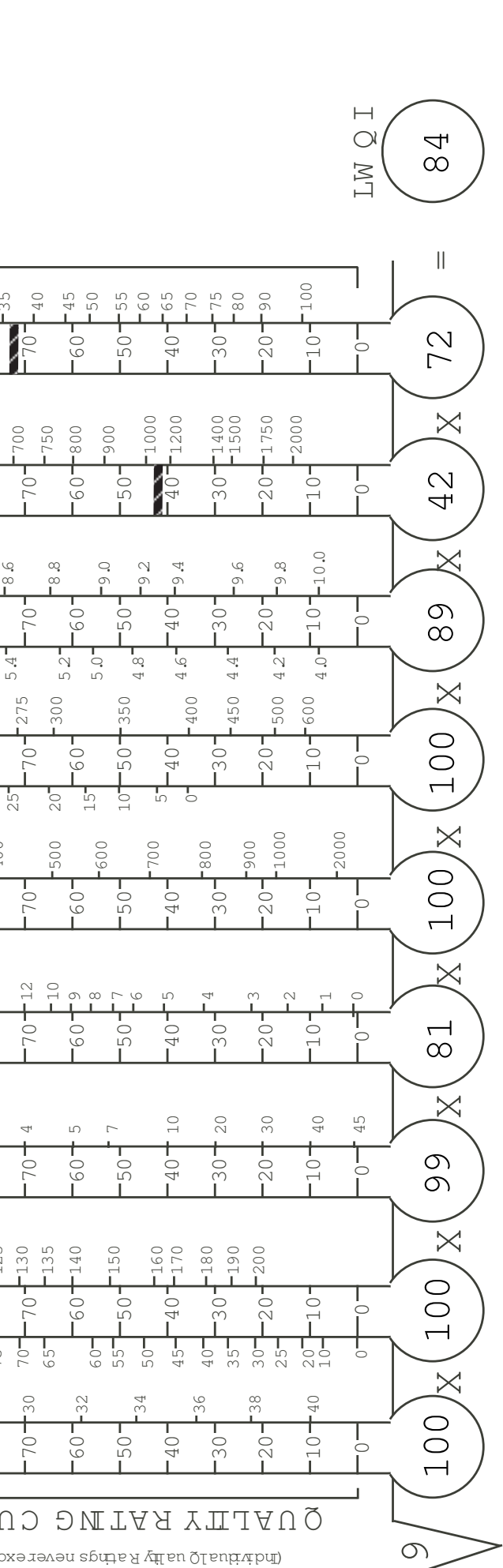

SET THE PARAMETER QUALITY RATING AT 1 IF THE EXTREMAL EXTREME VALUE RANGE IS EXCEEDED

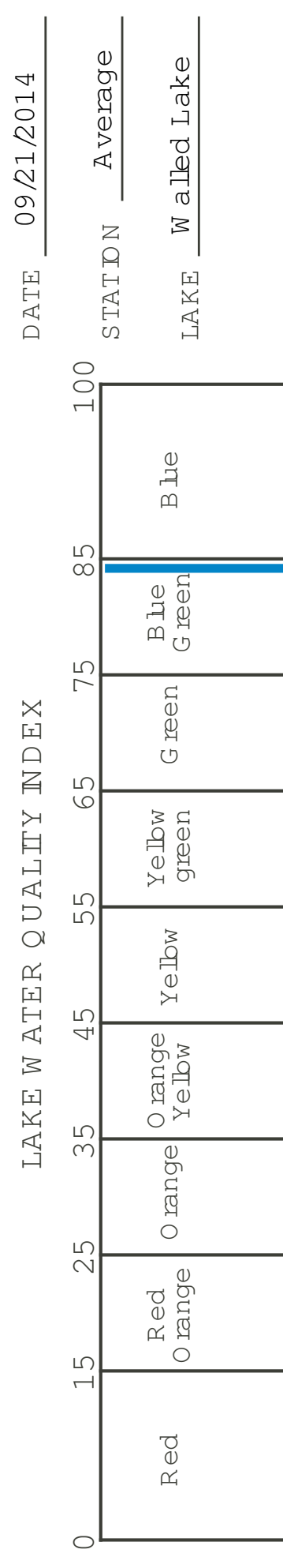

DATE: 09/21/2014