



# COMMUNITY DEVELOPMENT DEPARTMENT

45175 Ten Mile Road  
Novi, MI 48375  
(248) 347-0415 Phone  
(248) 735-5600 Facsimile  
[www.cityofnovi.org](http://www.cityofnovi.org)

## ZONING BOARD OF APPEALS STAFF REPORT

FOR: City of Novi Zoning Board of Appeals

ZONING BOARD APPEALS DATE: December 8, 2020

REGARDING: Shawood Drive, Parcel # 50-22-10-228-018 (PZ20-0053)

BY: Larry Butler, Deputy Director Community Development

### I. GENERAL INFORMATION:

#### Applicant

Z. Joe Huang

#### Variance Type

Dimensional Variance

#### Property Characteristics

Zoning District:

Single Family Residential

Location:

West of Old Novi Road and South of Thirteen Mile Road

Parcel #:

50-22-10-228-018

#### Request

The applicant is requesting variance from the Novi Zoning Ordinance Section 3.1.5 for a proposed lot coverage of 27% (25% required, variance of an increased 2%). Section 3.6.2M for a watercourse setback of 10 feet (25 feet minimum required, variance of 15 feet). This variance will accommodate the building of a new home. This property is zoned Single Family Residential (R-4).

### II. STAFF COMMENTS:

### III. RECOMMENDATION:

The Zoning Board of Appeals may take one of the following actions:

1. I move that we grant the variance in Case No. **PZ20-0053**, sought by \_\_\_\_\_, for \_\_\_\_\_ because Petitioner has shown practical difficulty requiring \_\_\_\_\_.

  - (a) Without the variance Petitioner will be unreasonably prevented or limited with respect to use of the property because \_\_\_\_\_.
  - (b) The property is unique because \_\_\_\_\_.

(c) Petitioner did not create the condition because \_\_\_\_\_  
\_\_\_\_\_.

(d) The relief granted will not unreasonably interfere with adjacent or surrounding properties because \_\_\_\_\_  
\_\_\_\_\_.

(e) The relief is consistent with the spirit and intent of the ordinance because \_\_\_\_\_  
\_\_\_\_\_.

(f) The variance granted is subject to:

1. \_\_\_\_\_.
2. \_\_\_\_\_.
3. \_\_\_\_\_.
4. \_\_\_\_\_.

2. I move that we **deny** the variance in Case No. **PZ20-0053**, sought by \_\_\_\_\_  
for \_\_\_\_\_ because Petitioner has not shown practical difficulty requiring \_\_\_\_\_.

(a) The circumstances and features of the property including \_\_\_\_\_ are not unique because they exist generally throughout the City.

(b) The circumstances and features of the property relating to the variance request are self-created because \_\_\_\_\_  
\_\_\_\_\_.

(c) The failure to grant relief will result in mere inconvenience or inability to attain higher economic or financial return based on Petitioner's statements that \_\_\_\_\_.

(d) The variance would result in interference with the adjacent and surrounding properties by \_\_\_\_\_.

(e) Granting the variance would be inconsistent with the spirit and intent of the ordinance to \_\_\_\_\_  
\_\_\_\_\_.

Should you have any further questions with regards to the matter please feel free to contact me at (248) 347-0417.

Larry Butler  
Deputy Director Community Development  
City of Novi



45175 Ten Mile Road  
 Novi, MI 48375  
 (248) 347-0415 Phone  
 (248) 735-5600 Facsimile  
[www.cityofnovi.org](http://www.cityofnovi.org)

# ZONING BOARD OF APPEALS APPLICATION

**APPLICATION MUST BE FILLED OUT COMPLETELY**

<b>I. PROPERTY INFORMATION (Address of subject ZBA Case)</b>				Application Fee: _____	
PROJECT NAME / SUBDIVISION Shawood Walled Lake Heights Sub-division				Meeting Date: _____	
ADDRESS 0000 Shawood Dr, Novi, MI 48377		LOT/SUITE/SPACE # Vacant Lot		ZBA Case #: PZ _____	
SIDWELL # 50-22- 10 - 228 - 018		May be obtain from Assessing Department (248) 347-0485			
CROSS ROADS OF PROPERTY Shawood Drive and Pleasant Cove Drive					
IS THE PROPERTY WITHIN A HOMEOWNER'S ASSOCIATION JURISDICTION? <input type="checkbox"/> YES <input checked="" type="checkbox"/> NO			REQUEST IS FOR: <input checked="" type="checkbox"/> RESIDENTIAL <input type="checkbox"/> COMMERCIAL <input type="checkbox"/> VACANT PROPERTY <input type="checkbox"/> SIGNAGE		
DOES YOUR APPEAL RESULT FROM A NOTICE OF VIOLATION OR CITATION ISSUED? <input type="checkbox"/> YES <input checked="" type="checkbox"/> NO					
<b>II. APPLICANT INFORMATION</b>					
<b>A. APPLICANT</b>		EMAIL ADDRESS jhuang127@gmail.com		CELL PHONE NO. 248-719-2345	
NAME Z. Joe Huang		TELEPHONE NO. 248-660-0380			
ORGANIZATION/COMPANY		FAX NO.			
ADDRESS 44903 Lafayette Dr		CITY Novi	STATE MI	ZIP CODE 48377	
<b>B. PROPERTY OWNER</b> <input type="checkbox"/> CHECK HERE IF APPLICANT IS ALSO THE PROPERTY OWNER					
Identify the person or organization that owns the subject property:		EMAIL ADDRESS		CELL PHONE NO. 248-760-0966	
NAME Katherine E. McNerney		TELEPHONE NO.			
ORGANIZATION/COMPANY c/o Shelly (Agent)		FAX NO.			
ADDRESS 49139 Summerwood Ct		CITY Farmington Hills	STATE MI	ZIP CODE 48334	
<b>III. ZONING INFORMATION</b>					
<b>A. ZONING DISTRICT</b>					
<input type="checkbox"/> R-A <input type="checkbox"/> R-1 <input type="checkbox"/> R-2 <input type="checkbox"/> R-3 <input checked="" type="checkbox"/> R-4 <input type="checkbox"/> RM-1 <input type="checkbox"/> RM-2 <input type="checkbox"/> MH <input type="checkbox"/> I-1 <input type="checkbox"/> I-2 <input type="checkbox"/> RC <input type="checkbox"/> TC <input type="checkbox"/> TC-1 <input type="checkbox"/> OTHER _____					
<b>B. VARIANCE REQUESTED</b>					
INDICATE ORDINANCE SECTION (S) AND VARIANCE REQUESTED:					
1. Section <u>3.6.2 Note M</u>		Variance requested		<u>Note Section ii) Water course setback: Required: 25 feet</u>	
2. Section _____		Variance requested		<u>Proposed: 10 feet; Variance requested: 15 feet (Preferred)</u>	
3. Section _____		Variance requested		<u>Alt. Variance: from 15ft to 10ft, &amp; front setback from 30ft to 25ft.</u>	
4. Section <u>3.1.5</u>		Variance requested		<u>Lot coverage: Required 25%, Proposed: 27%, Variance 2%</u>	
<b>IV. FEES AND DRAWINGS</b>					
<b>A. FEES</b>					
<input type="checkbox"/> Single Family Residential (Existing) \$200 <input type="checkbox"/> (With Violation) \$250 <input checked="" type="checkbox"/> Single Family Residential (New) \$250 <input type="checkbox"/> Multiple/Commercial/Industrial \$300 <input type="checkbox"/> (With Violation) \$400 <input type="checkbox"/> Signs \$300 <input type="checkbox"/> (With Violation) \$400 <input type="checkbox"/> House Moves \$300 <input type="checkbox"/> Special Meetings (At discretion of Board) \$600					
<b>B. DRAWINGS 1-COPY &amp; 1 DIGITAL COPY SUBMITTED AS A PDF</b>					
<ul style="list-style-type: none"> <li>• Dimensioned Drawings and Plans</li> <li>• Site/Plot Plan</li> <li>• Existing or proposed buildings or addition on the property</li> <li>• Number &amp; location of all on-site parking, if applicable</li> </ul>			<ul style="list-style-type: none"> <li>• Existing &amp; proposed distance to adjacent property lines</li> <li>• Location of existing &amp; proposed signs, if applicable</li> <li>• Floor plans &amp; elevations</li> <li>• Any other information relevant to the Variance application</li> </ul>		



# ZONING BOARD OF APPEALS APPLICATION

## V. VARIANCE

### A. VARIANCE (S) REQUESTED

DIMENSIONAL     USE     SIGN

There is a five-(5) hold period before work/action can be taken on variance approvals.

### B. SIGN CASES (ONLY)

Your signature on this application indicates that you agree to install a **Mock-Up Sign ten-(10) days** before the schedule ZBA meeting. Failure to install a mock-up sign may result in your case not being heard by the Board, postponed to the next schedule ZBA meeting, or cancelled. A mock-up sign is **NOT** to be actual sign. Upon approval, the mock-up sign must be removed within five-(5) days of the meeting. If the case is denied, the applicant is responsible for all costs involved in the removal of the mock-up or actual sign (if erected under violation) within five-(5) days of the meeting.

### C. ORDINANCE

#### City of Novi Ordinance, Section 3107 – Miscellaneous

No order of the Board permitting the erection of a building shall be valid for a period longer than one-(1) year, unless a building permit for such erection or alteration is obtained within such period and such erection or alteration is started and proceeds to completion in accordance with the terms of such permit.

No order of the Board permitting a use of a building or premises shall be valid for a period longer than one-hundred and eighty-(180) days unless such use is establish within such a period; provided, however, where such use permitted is dependent upon the erection or alteration or a building such order shall continue in force and effect if a building permit for such erection or alteration is obtained within one-(1) year and such erection or alteration is started and proceeds to completion in accordance with the terms of such permit.

### D. APPEAL THE DETERMINATION OF THE BUILDING OFFICIAL

PLEASE TAKE NOTICE:

The undersigned hereby appeals the determination of the Building Official / Inspector or Ordinance made

CONSTRUCT NEW HOME/BUILDING     ADDITION TO EXISTING HOME/BUILDING     SIGNAGE  
 ACCESSORY BUILDING     USE     OTHER \_\_\_\_\_

## VI. APPLICANT & PROPERTY SIGNATURES

### A. APPLICANT

Z. Joe Huang

Digitally signed by Z. Joe Huang  
 DN: cn=Z. Joe Huang, c=US,  
 o=AutoBytec, LLC, email=joe.  
 huang@autobytec.com  
 Date: 2020.10.16 18:38:22 -0400'

Applicant Signature

Date

### B. PROPERTY OWNER

**If the applicant is not the owner, the property owner must read and sign below:**

The undersigned affirms and acknowledges that he, she or they are the owner(s) of the property described in this application, and is/are aware of the contents of this application and related enclosures.

Authentisign  
 KATHERINE MCNERNEY

10/16/2020

Property Owner Signature

Date

## VII. FOR OFFICIAL USE ONLY

### DECISION ON APPEAL:

GRANTED

DENIED

The Building Inspector is hereby directed to issue a permit to the Applicant upon the following and conditions:

\_\_\_\_\_  
 Chairperson, Zoning Board of Appeals

\_\_\_\_\_  
 Date



**Community Development Department**

45175 Ten Mile Road  
Novi, MI 48375  
(248) 347-0415 Phone  
(248) 735-5600 Facsimile  
[www.cityofnovi.org](http://www.cityofnovi.org)

**REVIEW STANDARDS  
DIMENSIONAL VARIANCE**

The Zoning Board of Appeals (ZBA) will review the application package and determine if the proposed Dimensional Variance meets the required standards for approval. In the space below, and on additional paper if necessary, explain how the proposed project meets each of the following standards. (Increased costs associated with complying with the Zoning Ordinance will not be considered a basis for granting a Dimensional Variance.)

**Standard #1. Circumstances or Physical Conditions.**

Explain the circumstances or physical conditions that apply to the property that do not apply generally to other properties in the same zoning district or in the general vicinity. Circumstances or physical conditions may include:

- a. Shape of Lot.** Exceptional narrowness, shallowness or shape of a specific property in existence on the effective date of the Zoning Ordinance or amendment.

Not Applicable     Applicable    If applicable, describe below:

One side of the lot boundaries is located in the water inside a naturally formed lake inlet. While the proposed site plan meets rear setback of 35-feet per R-4 zoning code, it fails to comply 25-foot setback from water course edge per Section 3.6.2 Notes to District Standards, Section M-ii

*and/or*

- b. Environmental Conditions.** Exceptional topographic or environmental conditions or other extraordinary situations on the land, building or structure.

Not Applicable     Applicable    If applicable, describe below:

As an effort of preserving natural woods and the swamp on the adjacent lot to be purchased at the same time, a minimum variance of 2% in lot coverage will be sufficient to achieve that goal.

*and/or*

- c. Abutting Property.** The use or development of the property immediately adjacent to the subject property would prohibit the literal enforcement of the requirements of the Zoning Ordinance or would involve significant practical difficulties.

Not Applicable     Applicable    If applicable, describe below:

## **Standard #2. Not Self-Created.**

Describe the immediate practical difficulty causing the need for the Dimensional Variance, that the need for the requested variance is not the result of actions of the property owner or previous property owners (i.e., is not self-created).

The property line is drawn in the middle of a naturally-formed inlet on Shawood Lake shoreline (Refer to satellite map on Presentation). The property lines should be effective decades ago, well before the current zoning codes are in effect. Thus it is NOT self-created.

## **Standard #3. Strict Compliance.**

Explain how the Dimensional Variance in strict compliance with regulations governing area, setback, frontage, height, bulk, density or other dimensional requirements will unreasonably prevent the property owner from using the property for a permitted purpose, or will render conformity with those regulations unnecessarily burdensome.

By strict compliance of front setback of 30-feet from Right of Way, AND water course setback of 25-feet from its edge, it is nearly impossible for any decent size single family house to have a deck, a patio or a sun-room addition. Without these functions, it will make the proposed house far less enjoyable for outdoor activities at the backyard. Furthermore, it will affect the future property value that make the proposed development uneconomic.

We have a signed contract to purchase the adjacent lot (Sidwell # 50-22-10-228-017), and intent to leave it mostly in its natural state. By doing so, we should meet or exceed the spirit of the setback rules in nature preservation and neighborhood enhancement.

## **Standard #4. Minimum Variance Necessary.**

Explain how the Dimensional Variance requested is the minimum variance necessary to do substantial justice to the applicant as well as to other property owners in the district.

The proposed variance request is to reduce the water course setback from 25-feet to 10-feet. The resulted variance of 15-feet is a vacant land strip with a few 2-3-feet tall bushes. (Refer to the Presentation - Affected area by the variance request). Thus, the environmental impact should be minimum. The extra space is sufficient for a backyard deck, a patio, a sun room and a small study room. These additions slightly exceed 25% lot coverage requirement. An coverage increase from 25% to 27% will sufficiently address the small overage.

## **Standard #5. Adverse Impact on Surrounding Area.**

Explain how the Dimensional Variance will not cause an adverse impact on surrounding property, property values, or the use and enjoyment of property in the neighborhood or zoning district.

The variance request has little impact on neighbors and surrounding area for the following reasons:

- 1) The variance are all at the backyard of the house invisible to neighbors. Even for the next door neighbor, there is a high fence in between to make the variance out of sight.
- 2) We intend to keep the other side of vacant lot mostly in its natural state for environmental preservation (Refer to Presentation - Nature preservation on adjacent Lot 017). Hence, the setback variance will not be visible from the street traffic and pedestrians due to dense woods along the street.
- 3) By keeping the adjacent lot undeveloped, the proposed lot coverage variance of 2% will have a minimum impact visually and physically.

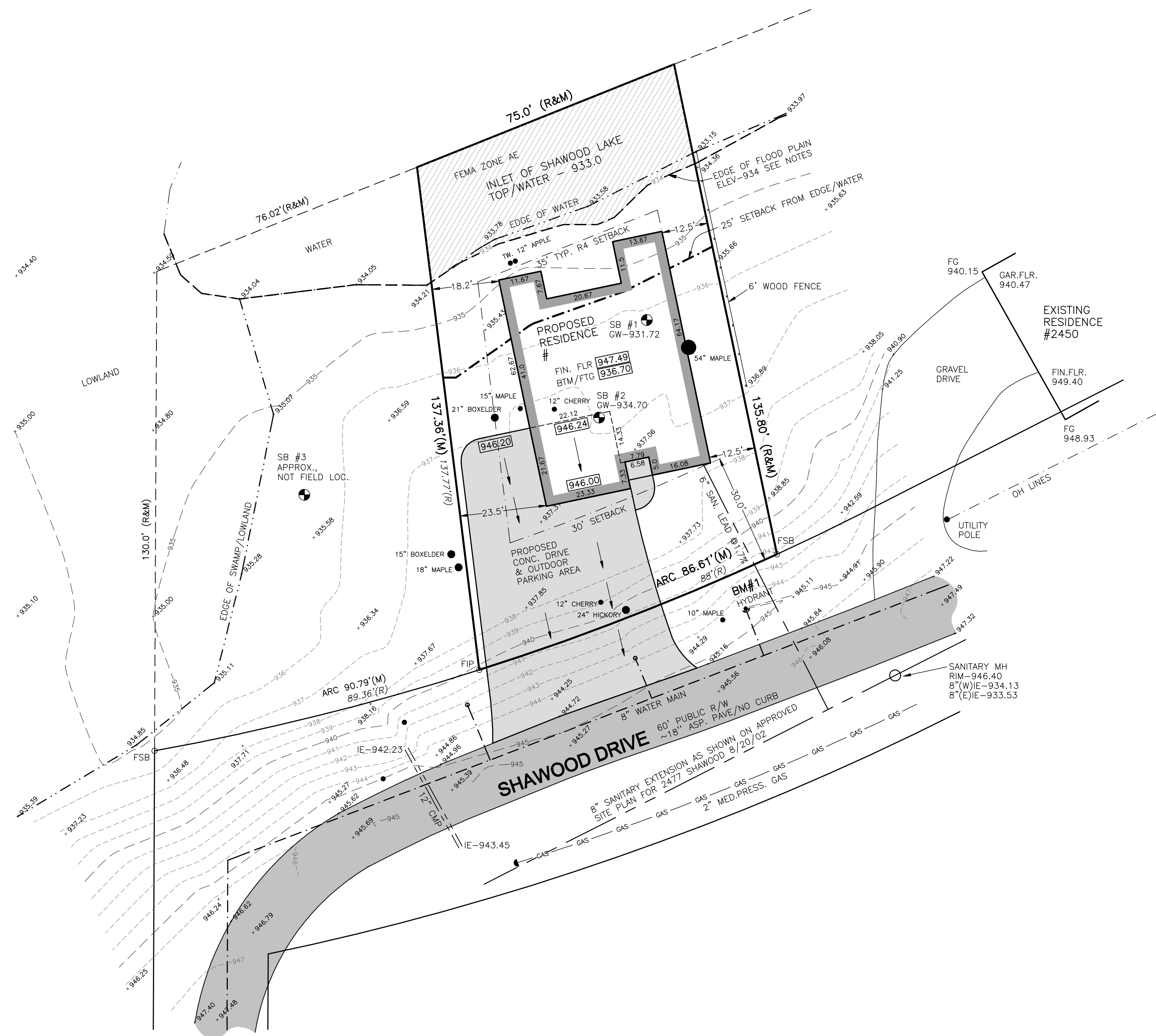
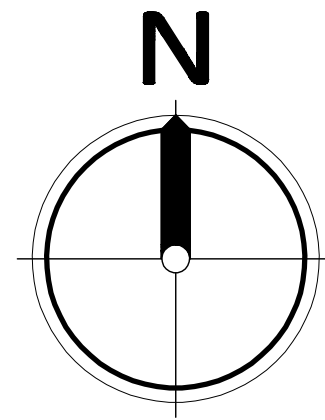

**PROPERTY DESCRIPTION:**

LOTS 149 AND 150, "SHAWOOD WALLED LAKE HEIGHTS SUBDIVISION", AS RECORDED IN LIBER 46 OF PLATS, PAGE 48, OAKLAND COUNTY RECORDS.

**SITE BENCHMARK:**

ARROW ON HYDRANT, NORTH SIDE SHAWOOD DR. ACROSS FROM NE CORNER LOT 159  
ELEVATION - 947.45

**FEMA FLOOD INFO**

PROPERTY, OTHER THAN EXTREME NORTH EDGE OF UPLAND LIES IN ZONE X, "AREA OF MINIMAL FLOODING". APPROXIMATE 2% OF UPLAND AREA LIES IN ZONE AE "SPECIAL FLOOD HAZARD AREAS SUBJECT TO INUNDATION BY THE 1% ANNUAL CHANCE FLOOD. BASE FLOOD ELEVATION DETERMINED TO BE 934 FEET.

ZONE AE  
FIRM PANEL 26125C0488F 09/29/2006

**SITE PLAN LEGEND**

- WATERMAIN
- SANITARY SEWER
- GAS MAIN
- OH ELEC/TELCOMM
- MINOR CONTOUR (EXISTING)
- MAJOR CONTOUR (EXISTING)

- 943.0 PROPOSED GRADE
- DRAINAGE DIRECTION
- 943.0 EXISTING GRADE

**SURVEY INFO LEGEND**

- (R) RECORDED AS
- (M) MEASURED AS
- FSB FOUND STEEL BAR

**BASIS FOR PROPOSED HOUSE ELEVATIONS:**

CRITICAL POINT: HIGHEST GW ELEVATION FOUND IN BUILD AREA @ SOIL BORING 2 (EX. GROUND ELEV. 936.95)  
GROUND WATER ENCOUNTERED @ 2'-3" (934.70)  
RECOMMENDED 2.0 FEET FROM WATER TABLE TO BASEMENT FLOOR. USED 2.0 FEET FROM WATER TABLE TO BTM OF FOOTING (936.70)

SB#2 GROUND ELEV FROM FIELD TOPO.  
ALL OTHER DATA AND RECOMMENDATIONS FROM McDOWELL & ASSOC. SOILS INVESTIGATION JOB NO. 20-245, DATED 10/6/20

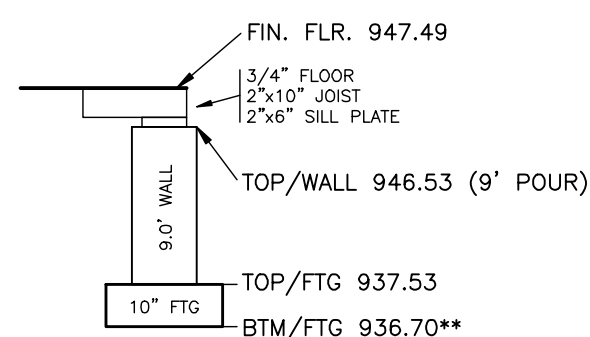

FIN. FLR. 947.49  
DOWN 2 STEPS @ 7.5\"/>

SANITARY INV. @ WYE ~934.45  
+ 75LF 6\"/>

UNDERGROUND UTILITY INFORMATION AS SHOWN WAS GATHERED IN PART FROM FIELD OBSERVATION AND IN PART FROM RECORDS OF THE VARIOUS UTILITY COMPANIES AND/OR MUNICIPAL RECORDS. NO GUARANTEE IS GIVEN OR IMPLIED AS TO THE ACCURACY AND/OR COMPLETENESS THEREOF.

CALL MISS-DIG (800) 482-7171 OR 811 AT LEAST 72 HOURS BEFORE COMMENCING ANY EXCAVATION

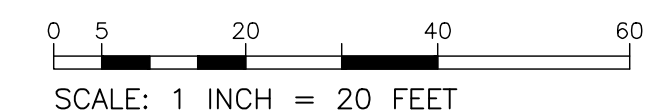

**PRELIMINARY**

RESIDENTIAL PLOT PLAN  
OAKLAND CO. TAX PARCEL 22-10-228-018  
VACANT SHAWOOD DRIVE  
CITY OF NOVI, OAKLAND CO., MICHIGAN

**SHEET 1 OF 1**

**David White Land Surveying, PLLC**  
Boundary - Topographic - Construction - ALTA  
44 DENNISON STREET, OXFORD, MICHIGAN 48371  
Professional Land Surveyor  
734.553.0135 dwsurveying@gmail.com

PREPARED FOR  
Z. JOE HUANG

JOB NO.	200912
DATE	10/09/20
FIELD DATE	09/27/20
FIELD BK	106
SHEET	1 OF 1
SCALE	1" = 20'
CHECKED	PJW

HORIZONTAL DATUM	LOCAL
VERTICAL DATUM	CITY OF NOVI
SOURCE	PLAN ON FILE

REVISIONS	DATE	COMMENT
REV.		

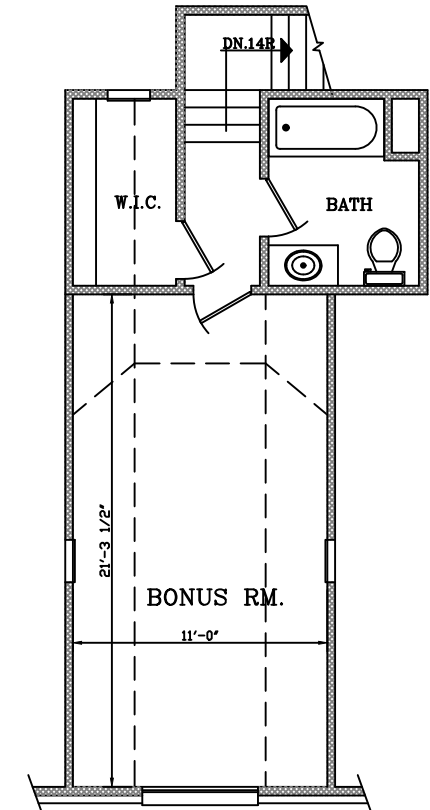
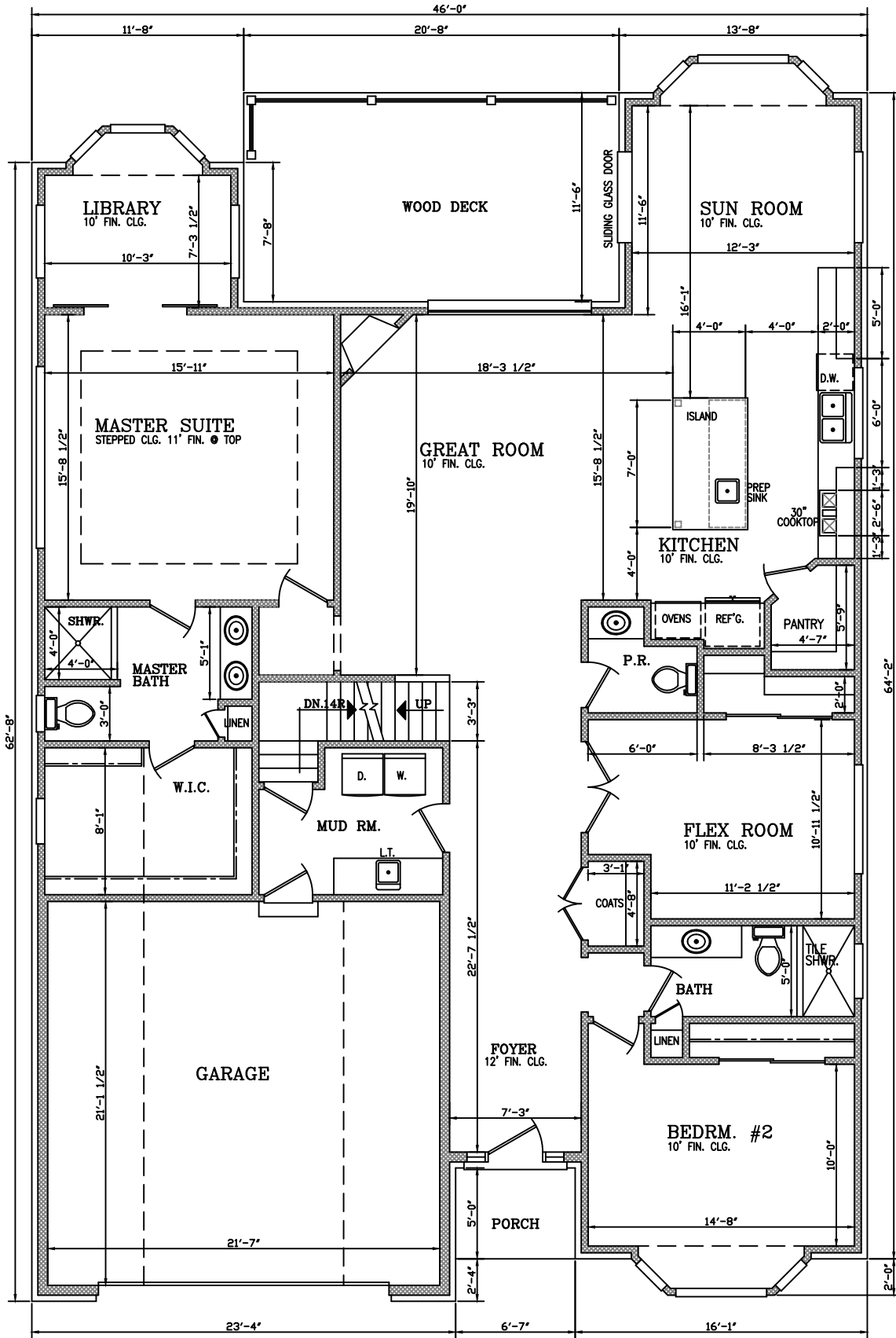

**BONUS ROOM PLAN**

SCALE: 1/4" = 1'-0"

**FIRST FLOOR PLAN**

SCALE: 1/4" = 1'-0"

**AREA**

FIRST FLOOR -	2,190 SQ. FT.
BONUS RM. -	360 SQ. FT.
TOTAL -	2,550 SQ. FT.
PORCH -	33 SQ. FT.
GARAGE -	500 SQ. FT.



# Proposed New Residential House Construction

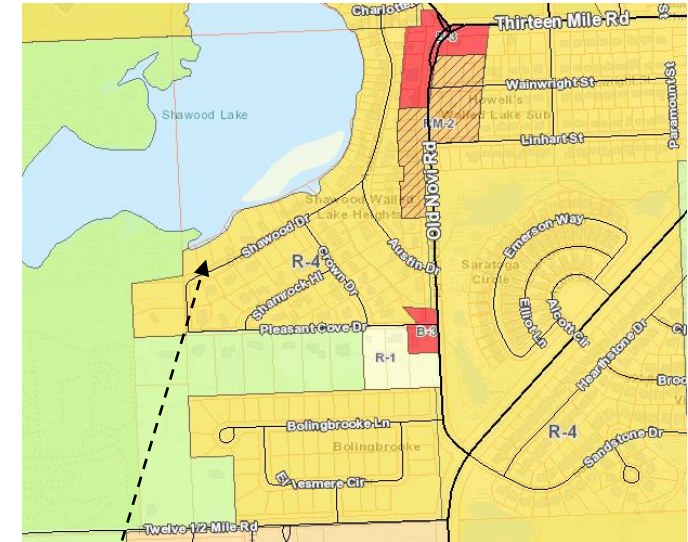
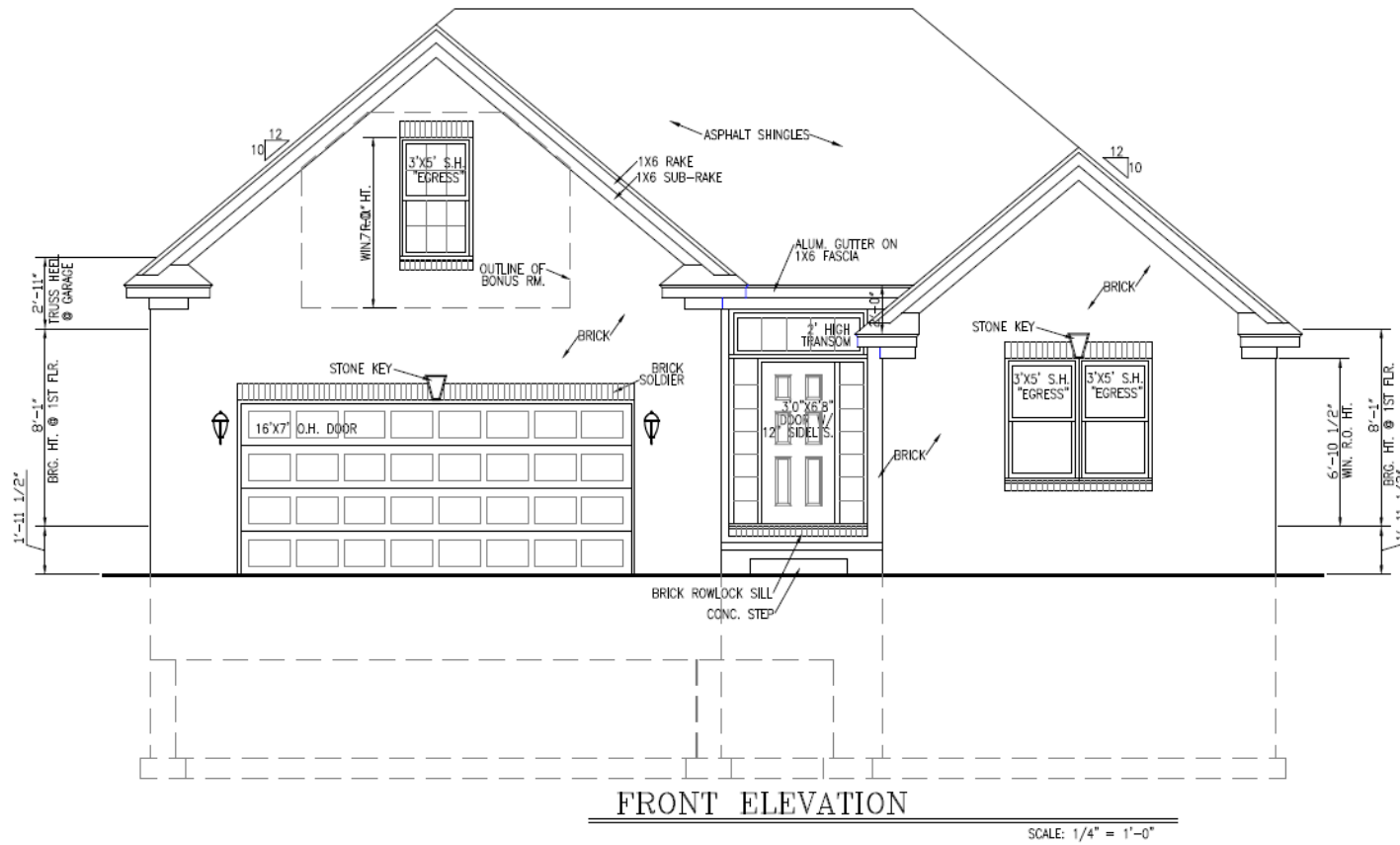

To be located at:  
Shawood Walled Lake Heights  
Parcel# 50-22-10-228-018  
One-Family Residential District  
Zoning Code: R-4

# Summary of Variance Request

## Request 1:

Preferred: Reduce Water Course Setback from 25 feet to 10 feet.

- Full compliance with Rear Setback of 35 feet
- Full compliance with Front Setback of 30 feet
- Elevation above FEMA 100-year flood plain.

## Alternative:

- Reduce Water Course Setback from 25 feet to 15 feet;
- Reduce Front Setback from 30 feet to 25 feet

Request 2: Increase of Lot Coverage from 25% to 27%



Novi Zoning Requirements  
Single Family R-4

Rear Setback  
> 35 feet

Front Setback  
> 30 feet

Water course setback  
requirement on zoning code  
Note M:

Water Course  
Setback  
> 25 feet

(Seeking Variance)

# Water Course Setback on Site Plan

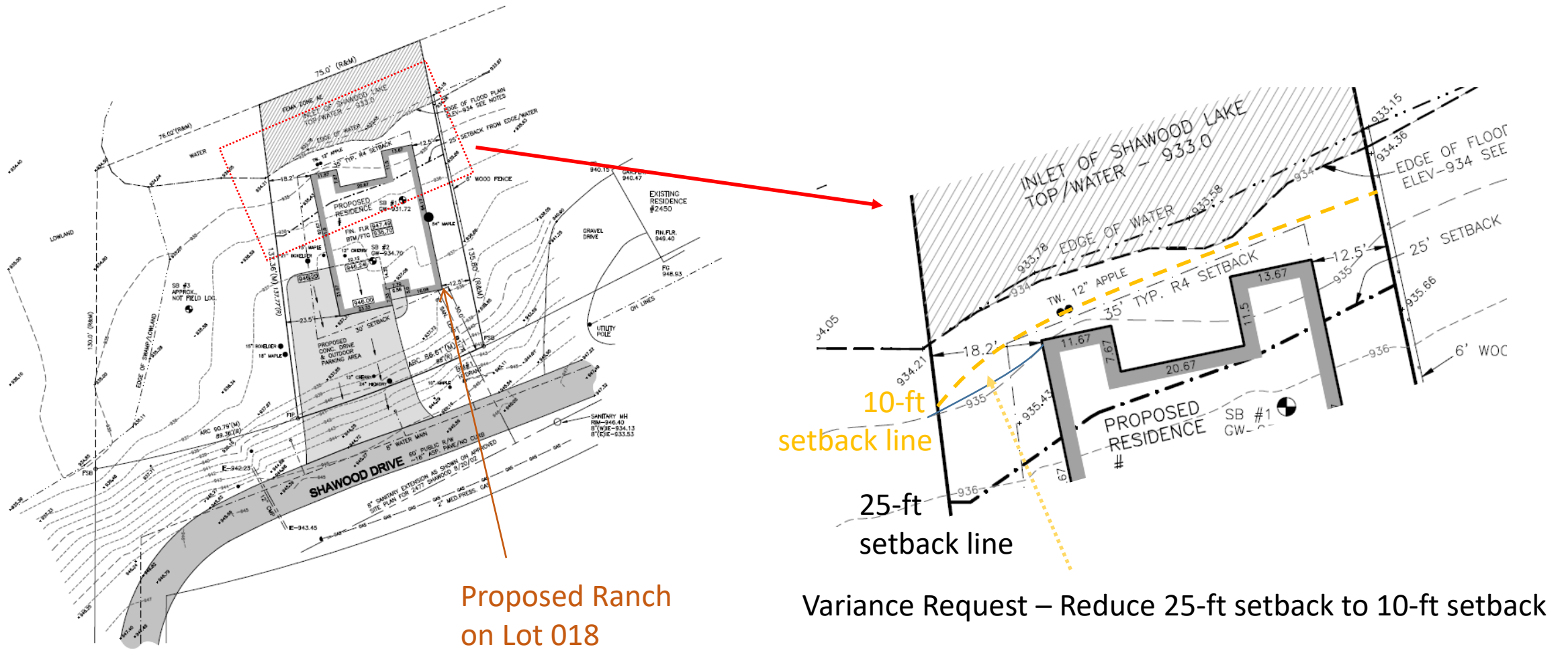

# Justifications on the variance request

- Based on lot's unique feature: a good portion is in the water on the back.
- The lot boundary was drawn well before the water course setback is in effect.
- The lot faces a lake inlet and has little impact on the overall Shawood Lake.
- By strictly applying all setback rules, the resulted single-family residential house becomes uneconomical to build.
- Affected 15-ft land strip has no special plants, and the environmental impact is to be offset by extra preservation efforts on the adjacent Lot 17.
- By keeping Lot 17 vacant for preservation purpose, the increase lot coverage from 25% to 27% on Lot 18 has minimum visual impact.
- Minimum impact on surrounding neighborhood.

# Affected area by the variance request

The variance request: reduce the water course setback from 25 feet to 10 feet.

The affected area is a 15-foot-wide strip with a few wild bushes within the red lines. At the end of the strip is the neighbor's fence.

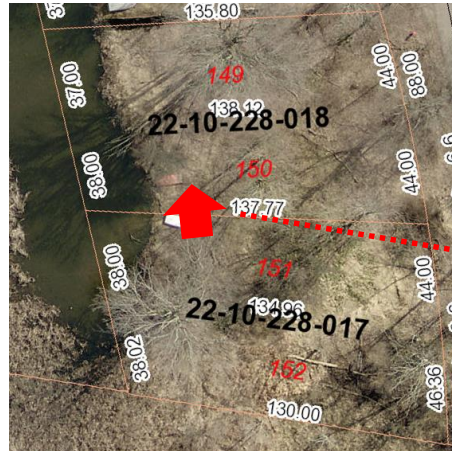

On the proposed site plan, the land strip is to be used for a deck on top, a patio at bottom, and a sun room extension on one side, and a study room on the other.

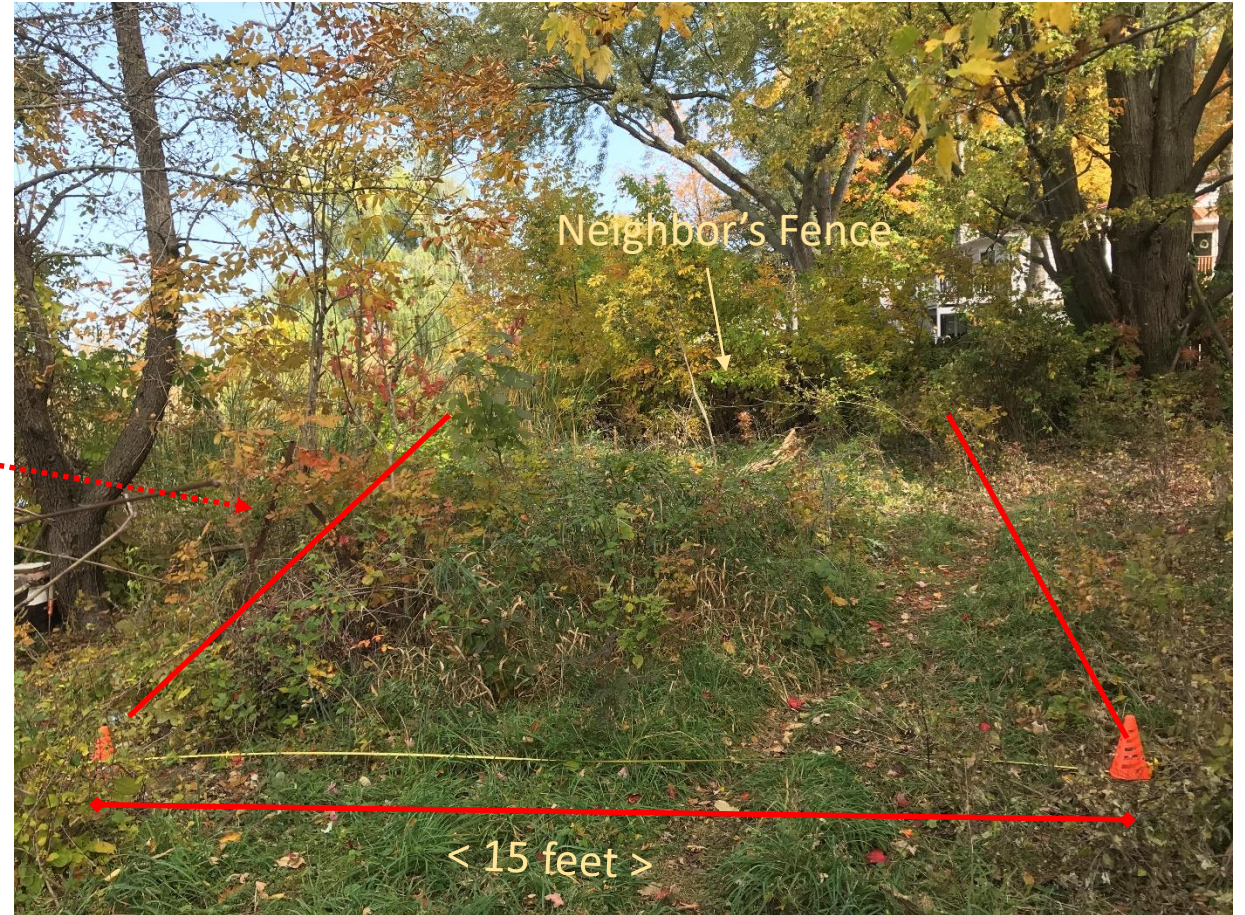

# Nature preservation on adjacent Lot 017



Preserve nature swamp, and road-side woods on adjacent Lot 017



# Other Helpful Info

ZBA Precedent & Compliance Status on Setback Rules



# Past Precedent on ZBA Variance Requests from Neighbors

**Case No. 06-021 filed by James Weiner at 2094 Austin Drive\*, granted on 3/7/2006 by ZBA**

4 variances are granted as below:

Required front yard setback	30 feet
Proposed front yard setback	18.75 feet
Variance requested	11.25 feet

Required side yard setback (south)	15 feet
Proposed side yard setback (south)	13.5 feet
Variance requested	1.5 feet

Required total both side yards	25 feet
Proposed total both side yards	23.5 feet
Variance requested	1.5 feet

Proposed lot coverage	27 %
Maximum lot coverage	25 %
Variance requested	2 %

\* Austin Drive is the same street as Shawood Drive with a different name.



# Neighboring House Setback on Shawood Drive

Proposed  
Lot 018

Vacant  
Lot

Building structures inside 25-foot setback from water course



Neighboring houses with < 30-foot front setback

Vacant Lot

Compliant

# Setback Compliance Statistics by Neighbors

Out of a total of 11 houses / lots on Shawood Drive at the lake side:

- Front Setback non-compliance: 3 houses
- Water course setback non-compliance: 3 houses
- Vacant Lot: 2 units
- Full compliance on both setback: 1 house