



CITY of NOVI CITY COUNCIL

Agenda Item C
October 12, 2015

SUBJECT: Approval to award contract for the 2015 Fall Tree and Landscape Planting to the lowest bidder, RC Tuttle Refinishing Co., for the amount of \$70,413, and to concurrently amend the FY 15/16 budget.

SUBMITTING DEPARTMENT: Community Development *Barb*

CITY MANAGER APPROVAL: *[Signature]*

EXPENDITURE REQUIRED	\$ 70,413.00
AMOUNT BUDGETED	\$ 60,000.00
APPROPRIATION REQUIRED	\$ 10,413.00
LINE ITEM NUMBER	209-000.00-972.100 (City Tree Fund)

BACKGROUND INFORMATION:

The annual fall planting for 2015 includes a wide variety of tree species in multiple locations. Each location was chosen in keeping with the City's commitment to the natural environment, as well as the continued effort to expand on the positive community image. Over 220 trees and large shrubs, plus a number of perennials and ornamental grasses, will be installed under this contract. Included are the following locations:

- **Residential Street Trees.** Up to 100 homes will be planted with street trees to enhance the homes and streetscapes throughout the City. Residents will be notified before the plantings commence. Locations are most often selected through ongoing monitoring and maintenance by forestry staff. Criteria determining need include plant health concerns or accidental injuries. City staff also responds to resident concerns about City street trees and takes appropriate action, whether it is care, monitoring or replacement, if warranted.
- **Brookfarm Park** – 23 canopy and evergreen trees are proposed to add shade for the stream, to help keep its water temperature cool, and to add additional clusters of trees in other areas of the park to provide shade and interest.
- **Civic Center** – A single ornamental dogwood and 12 red osier dogwood shrubs are proposed for the western side of the south entrance where there is a gap in the landscaping. These will provide both summer and winter interest in the area. 18 additional red osier dogwood shrubs will be planted on the south side to fill in gaps and increase the summer and winter beauty of that side of the building.
- **Ella Mae Power Park** – A mix of canopy and subcanopy trees are proposed to increase the area of the natural woods there, and to fill holes in some existing planting areas. A total of 30 trees of 6 different species are proposed.
- **Village Wood Park** – 10 new canopy trees are proposed to beautify the park and increase the diversity of the trees in it.

- **Wildlife Woods Park** – A mix of additional canopy trees is proposed for the periphery of the woods, to increase the available habitat and reduce areas of mowing that aren't necessary for the park's programs. A total of 18 trees are proposed.
- **Gateway Signs** – All of the "Welcome to Novi" gateway signs' landscaping will get some level of upgrade this fall, with some receiving overhauls and others receiving some additional plantings or upkeep to improve their appearance. Evergreens to match the existing evergreens will be added where necessary, as will deciduous shrubs, grasses and long-flowering perennials. Daffodil bulbs will also be planted to add early spring color to the signs.

The original budget amount was lower than the lowest bid received, which was RC Tuttle. We believe that the unit prices are fair, based on the continued high demand for trees around the area, the difficulty in getting trees based on the weather this late summer and fall, and the sizes of trees requested in the bid package. RC Tuttle has been informed that it is possible that the number of trees will be reduced to a number closer to the budgeted amount, if Council chooses. Any increase or decrease is to be based upon the unit costs of the materials. The City's tree fund can sustain the increase and moving forward Administration will budget accordingly.

As mentioned above, the trees and shrubs selected are quite varied. This will help to increase the diversity of plantings around the City. Staff based plant selection on pertinent site factors such as soil conditions, proximity to adjacent vegetation, locations of overhead and underground utilities, site exposure and growing space available to assure healthy tree growth and sustainability. In conjunction with Community Development, the Public Services Department has been and will continue to prepare sites for the new installations. The work includes removing any dead, damaged or diseased trees, and stump grinding. The City's Landscape Architect will be staking all locations prior to commencement of plantings. Trees will be inspected by staff to ensure specimen quality and proper installation.

Plantings are expected to commence in October as soon as the contract is awarded, and continue into mid-November. All plantings will be warranted by the contractor for a period of two years. Bids were received and opened on Thursday, October 1, 2015. Bid submittals were reviewed by staff within the Departments of Community Development and Finance. RC Tuttle is the lowest bidder and has the qualifications required under this contract. They have also previously worked with the city on tree plantings. Please see the attached bid tabulation sheet for detailed bid information.

The source of the funding is the City Tree Fund. The Fund is provided by developer payments for regulated woodlands that are removed during development projects and that cannot be replaced on the project site. Over past decades, the City's Woodland Ordinance has helped the City of Novi set a strong pace of private development coupled with the preservation and creation of diverse woodlands.

RECOMMENDED ACTION: Approval to award contract for the 2015 Fall Tree and Landscape Planting to the lowest bidder, RC Tuttle Refinishing Co., for the amount of \$70,413 and to concurrently amend the FY 15/16 budget.

	1	2	Y	N
Mayor Gatt				
Mayor Pro Tem Staudt				
Council Member Casey				
Council Member Markham				

	1	2	Y	N
Council Member Mutch				
Council Member Poupard				
Council Member Wrobel				

RESOLUTION

NOW, THEREFORE BE IT RESOLVED that the following Budget Amendment for the 2015 Fall Tree and Landscaping Planting is authorized:

	INCREASE (DECREASE)
TREE FUND	
APPROPRIATIONS	
Other Services and Charges	10,413
TOTAL APPROPRIATIONS	<u><u>\$ 10,413</u></u>
Net Increase (Decrease) to Fund Balance	<u><u>\$ (10,413)</u></u>

I hereby certify that the foregoing is a true and complete copy of a resolution adopted by the City Council of the City of Novi at a regular meeting held on October 12, 2015

Maryanne Cornelius
City Clerk

CITY OF NOVI

**BID #1 - SUBDIVISION TREE PLANTING & 9 MILE RD
(2 YR WARRANTY)**

	Qty	RC Tuttle		Agroscaping	
		Unit Price	TOTAL	Unit Price	TOTAL
TILIA americana 'Redmond' American Basswood 3" caliper	20	300	6,000	395	7,900
TILIA cordata 'Greenspire' Greenspire Littleleaf Linden 3" caliper	15	300	4,500	415	6,225
GYMNOCLADUS dioica Kentucky Coffeetree 3" caliper	20	300	6,000	435	8,700
ULMUS americana 'Valley Forge' Valley Forge Elm 3" caliper - spring dug	20	300	6,000	435	8,700
ACER saccharum 'Green Mountain' Green Mountain Sugar Maple 3" caliper	30	300	9,000	425	12,750
ACER rubrum 'Red Sunset' October Glory Red Maple 3" caliper - spring dug	5	300	1,500	425	2,125
OSTRYA virginiana Ironwood 2" caliper - spring dug	5	300	1,500	355	1,775
TOTAL BID 1	115		34,500		48,175

BID #2 - VILLAGE WOOD LAKE PARK (2 YR WARRANTY)

	Qty	Unit Price	TOTAL	Unit Price	TOTAL
GYMNOCLADUS dioica Kentucky Coffeetree 3" caliper	5	285	1,425	435	2,175
ACER saccharum 'Commemoration' Commemoration Sugar Maple 3" caliper	5	285	1,425	425	2,125
TOTAL BID 2	10		2,850		4,300

**BID #3 - BROOKFARM PARK
(2 YR WARRANTY)**

	Qty	Unit Price	TOTAL	Unit Price	TOTAL
TILIA americana 'Redmond' American Basswood 3" caliper	5	285	1,425	395	1,975
GYMNOCLADUS dioica Kentucky Coffeetree 3" caliper	10	285	2,850	435	4,350
PINUS strobus Eastern White Pine 6-8' height	8	200	1,600	345	2,760
TOTAL BID 3	23		5,875		9,085

BID #4 - POWER PARK (2 YR WARRANTY)

	Qty	Unit Price	TOTAL	Unit Price	TOTAL
TILIA americana 'Redmond' American Basswood 3" caliper	3	270	810	395	1,185
ACER saccharum 'Commemoration' Commemoration Sugar Maple 3" caliper	12	275	3,300	425	5,100
AMELANCHIER laevis Serviceberry 5-6' clump	2	250	500	225	450
CARPINUS caroliniana Muscledwood 2" caliper-spring dug	3	275	825	345	1,035
OSTRYA virginiana Ironwood 2" caliper - spring dug	2	275	550	355	710
MALUS 'Snowdrift' Snowdrift Flowing Crabapple 2" caliper	8	230	1,840	275	2,200
TOTAL BID 4	30		7,825		10,680

CITY OF NOVI

**BID #5 - WILDLIFE WOODS PARK
(2 YR WARRANTY)**

		RC Tuttle		Agroscaping	
	Qty	Unit Price	TOTAL	Unit Price	TOTAL
ACER saccharum 'Commemoration' Commemoration Sugar Maple 3" caliper	13	270	3,510	375	4,875
TILIA americana 'Redmond' American Basswood 2.5" caliper	5	270	1,350	365	1,825
TOTAL BID 5	18		4,860		6,700

BID #6 - CIVIC CENTER/POLICE STATION (2 YR WARRANTY)

	Qty	Unit Price	TOTAL	Unit Price	TOTAL
CORNUS alternifolia Pagoda Dogwood 6-7' height, single stem - spring dug	1	270	270	325	325
CORNUS sericea 'Farrow' Arctic Fire Red Osier Dogwood 5 gal	20	85	1,700	75	1,500
CORNUS sericea 'Kelsey' Kelsey Red Osier Dogwood 5 gal	10	85	850	75	750
TOTAL BID 6	31		2,820		2,575

BID #7 - PAVILION SHORE PARK (2 YR WARRANTY)

	Qty	Unit Price	TOTAL	Unit Price	TOTAL
JUNIPERUS chinensis 'Skyrocket' Skyrocket Juniper 5-6' height	18	120	2,160	175	3,150
JUNIPERUS chinensis 'Skyrocket' Skyrocket Juniper 6-7' height	4	120	480	235	940
AMELANCHIER laevis Serviceberry 5-6' clump	3	200	600	225	675
PENNISETUM alopecuroides Fountain Grass 1 gal	5	15	75	23.50	118
PENNISETUM alopecuroides 'Hameln' Hameln Fountain Grass 1 gal	4	15	60	23.50	94
PENNISETUM alopecuroides 'Little Bunny' Dwarf Fountain Grass 1 gal	107	15	1,605	19.50	2,087
PANICUM virgatum 'Northwind' Northwind Switchgrass 1 gal	3	15	45	23.50	71
GERANIUM Gerzat 'Rozanne' Rozanne Geranium 1 gal	92	15	1,380	18.50	1,702
COREOPSIS verticillata 'Zagreb' Zagreb Coreopsis 1 gal	90	15	1,350	19.50	1,755
ROSA sp Red Single Knockout Rose #3 cont.	1	60	60	37.50	38
RUDBECKIE fulgida 'Goldsturm' Black-eyed Susan 1 gal	11	15	165	16.50	182
NARCISSUS bulbs - Holland Sensation 6" o.c. spacing	528	1	528	1.95	1,030
Double-shredded hardwood mulch - natural color, 3" per bed (cubic yards)	65	45	2,925	75	4,875
Transplant 2 trees	2		250		500
TOTAL BID 7	933		11,683		17,214

TOTAL BID 1-7

\$ 70,413.00

\$ 98,729.10

Math error on Agroscaping bid # 3.

CONTRACT FOR 2015 FALL LANDSCAPE PLANTING

THIS CONTRACT FOR SERVICES AND MATERIALS ("Contract"), shall be considered as made and entered into as of the date of the last signature ("Effective Date"), and is between the City of Novi, a Michigan municipal corporation, whose address is 45175 Ten Mile, Novi, Michigan 48375, (hereinafter referred to as "Client"), and R. C. Tuttle Refinishing Co., whose address is 2475 S. Hickory Ridge Trail, Milford, MI 48380, (hereinafter referred to as "Contractor").

THE CLIENT AND CONTRACTOR AGREE AS FOLLOWS:

Article I. Statement and Performance of Work.

For payment by the Client as provided under this Contract, Contractor shall provide the materials and perform the services described on and in Schedule A (the "Work"), which is attached hereto and made a part of this Contract by this reference, in a competent, accurate, efficient, timely, good, professional, thorough, complete and responsible manner, and in compliance with the terms and conditions set forth below.

Article II. Timing of Performance.

Performance of this Contract shall commence on October 13, 2015. The completion date for all services and delivery of all materials as described in Schedule A shall be November 13, 2015. The timing for performance of any such work may also be extended, if allowed in writing by the Client in its sole discretion.

Article III. Contract Price and Payment.

Subject to the terms and conditions of this Contract, the Client agrees to pay Contractor an amount for services and materials based on unit pricing as specifically set forth in the completed Proposal attached which is part of the attached Schedule A. Such payments are in exchange for and consideration of the timely and satisfactory performance and completion of the work required under and pursuant to this Contract. Itemized billings detailing all materials provided, locations of plantings, and work performed shall be submitted and shall be paid only upon satisfactory completion of the work itemized in the billing.

All costs and expenses incurred by Contractor under this Contract are deemed to be included in the amounts set forth in Schedule A, unless specifically identified in Schedule A as reimbursable expenses and such expenses have been approved by the Client or its designee. Contractor will obtain written approval of the Client prior to proceeding with any work that is not stated on Schedule A; otherwise, the Client will not be billed for such extra/additional work.

Payments shall be made upon verification of invoices received by the Client. All payments to Contractor shall be submitted by mail at Contractor's address first listed above, unless Contractor provides written notice of a change in the address to which such payments are to be sent.

Article IV: Termination.

- A. 1. For cause: In the event that either party shall breach the terms and conditions of this Contract, the aggrieved party may notify the other party, in writing via certified mail, of such breach and demand that the same be remedied within ten (10) days. If the defaulting party fails to remedy the breach as demanded, the aggrieved party shall then have the right to terminate by giving the defaulting party thirty (30) days written notice. In addition, if at any time a voluntary petition in bankruptcy shall be filed against either party and shall not be dismissed within thirty (30) days, or if either party shall take advantage of any insolvency law, or if a receiver or trustee of any of a party's property shall be appointed and such appointments shall not be vacated within thirty (30) days, the other party shall have the right, in addition to any other rights of whatsoever nature that it may have at law or in equity, to terminate by giving thirty (30) days notice in writing of such termination.
2. For convenience: The Client may terminate the agreement, in whole or in part, without showing cause upon giving thirty (30) days written notice to the Contractor. The Client shall pay all reasonable costs incurred by the Client up to the date of notice of termination. The Contractor will not be reimbursed for any anticipatory profits that have not been earned up to the date of notice of termination.
- B. In the event this Contract is terminated before completion, the Client shall not be responsible to make any further payments for work performed after the effective date of such termination, and shall pay Contractor for such materials as have been delivered and for such work as has been completed and is eligible for payment under the terms of this Contract through the date of such termination. In all events, the Client shall only be responsible to make the payments described in the preceding sentence if, at the Client's request, Contractor continues to fully perform its duties and obligations in full compliance with the terms of this Contract through the effective date of the termination.

Article V: Independent Contractor/Vendor Relationship.

- A. In the performance of this Contract, the relationship of Contractor to the Client shall be that of an independent contractor and/or vendor and not that of an employee or agent of Client. Contractor is and shall perform under this Contract as an independent contractor and/or vendor, and no liability or responsibility with respect to benefits of any kind, including without limitation, medical benefits, worker's compensation, pension rights, or other rights or liabilities arising out of or related to a contract for hire or employer/employee relationship shall arise or accrue to either party as a result of the performance of this Contract.
- Contractor, as an independent contractor and/or vendor, is not authorized to enter into or sign any agreements on behalf of the Client or to make any representations to third parties that are binding upon the Client.
- B. Contractor represents that it will dedicate sufficient resources and provide all necessary personnel required to perform the work described in Schedule A in accordance with the terms and conditions of this Contract. Except as may be specifically stated and agreed to in Schedule A, Contractor shall perform all of the work under this Contract and no other person or entity shall be assigned or sub-

contracted to perform the work, or any part thereof, unless approved by the Client in advance.

Article VI: Liability and Insurance.

- A. Contractor agrees to indemnify and hold harmless the Client, its elected and appointed officials and employees, from and against any and all claims, demands, suits, losses and settlements, including actual attorney fees incurred and all costs connected therewith, for any damages which may be asserted, claimed or recovered against the Client by reason of (i) personal injury, death and/or property damages which arises out of or is in any way connected or associated with the actions or inactions of Contractor in performing or failing to perform the work; or (ii) civil damages which arise out of any dispute between Contractor and its subcontractors, affiliates, employees or other private third parties in connection with this Contract. Contractor specifically agrees that it is Contractor's responsibility, and not the responsibility of the Client, to safeguard the property and materials used in performing this Contract. Contractor agrees to hold the City harmless from any loss of or damage to such property and materials used in connection with Contractor's performance of this Contract.
- B. Contractor shall provide evidence of adequate insurance coverage in the types and amounts set forth on Schedule A, which is attached hereto and incorporated herein by this reference. Such insurance shall be maintained at the specified level of coverage throughout the term of this Contract, including any extension of such term, and will cover all work, acts and omissions by and on behalf of Contractor in connection with this Contract, with the Client as named additional insureds, but with such coverage being primary and non-contributory as described in the attached Schedule A.

Article VII: Information.

It is expressly acknowledged and agreed that all reports, opinions, compilations, research work, studies, data, materials, artifacts, samples, documents, plans, drawings, specifications, correspondence, ledgers, permits, manuals, applications, contracts, accountings, schedules, maps, logs, invoices, billings, photographs, videotapes and all other materials generated by and/or coming into the possession of Contractor during the term of this Contract, and any extension thereof, that in any way relate to the performance of work by Contractor under this Contract or that are otherwise related or relevant to the work, belong exclusively to the Client and shall be promptly delivered to the Client upon the termination of this Contract or, at any time, upon the Client's request.

Article VIII: General Provisions.

- A. Entire Agreement. This instrument, together with the attached Schedules, contains the entire Contract between the Client and Contractor. No verbal agreement, conversation, or representation by or between any officer, agent, or employee of the parties hereto, either before or after the execution of this Contract, shall affect or modify any of the terms or obligations herein contained.

- B. Compliance with Laws. This Contract and all of Contractor's work and practices shall be subject to all applicable state, federal and local laws, ordinances, rules or regulations, including without limitation, those which apply because Client is a public governmental agency or body. Contractor represents that it is in compliance with all such laws and eligible and qualified to enter into this Contract.
- C. Governing Law. This Contract shall be governed by the laws of the State of Michigan.
- D. Assignment. Contractor shall not assign this Contract or any part thereof without the written consent of the Client. This Contract shall be binding on the parties, their successors, assigns and legal representatives.
- E. Dispute Resolution/Arbitration. The parties agree that any disputes regarding a claimed violation of this agreement shall first be submitted in writing to the other party in an attempt to settle the matter before pursuing other legal actions or notices provided for in this agreement. Such written communication shall clearly state the problem or concern, allow sufficient time for a written response from the other party, and culminate in a face-to-face meeting to determine if a remedial action is possible. In no event shall this process take more than thirty (30) days, unless a specific extended period of time is agreed to by both parties in writing as being necessary. The aforementioned initial written communications between the parties also shall indicate whether the party is willing to submit the dispute to binding arbitration, non-binding mediation or other form of alternate dispute resolution, and share equally the costs for same. Upon the parties agreeing to any such method of dispute resolution and a timetable for doing so, pursuit of other legal actions shall be deferred until the process has been completed. In any binding arbitration, the arbitrator shall provide a written statement of the reasons and basis for an award or decision, a judgment of the Oakland County Circuit Court may be entered based on the arbitration award or decision, and each party shall be responsible for their own costs and attorney fees.
- F. Third Parties. It is the intention of the parties hereto that this Agreement is not made for the benefit of any private third party. It is acknowledged that Client may receive a portion of the funding for the payments under this Contract from one or more private sources, and it is understood by Contractor that it is hired by Client to work exclusively for Client (and by extension for the City should the work be accepted and implemented by the City) and Contractor agrees that no private party or parties will be allowed to hold sway or influence, in any way, over Contractor's performance of the work.
- G. Notices. Written notices under this Contract shall be given to the parties at their addresses contained in this Contract by personal or registered mail delivery to the attention of the following persons:
- Client: Peter E. Auger, City Manager, and Maryanne Cornelius, City Clerk
Contractor: Robert Sopsich, President
- H. Changes. Any changes in the provisions of this Contract must be in writing and signed by the Client and Contractor.

- I. Waivers. No waiver of any term or condition of this Contract shall be binding and effective unless in writing and signed by all parties, with any such waiver being limited to that circumstance only and not applicable to subsequent actions or events.
- J. Jurisdiction and Venue of Contract. This Contract shall be considered for all purposes, including the establishment of jurisdiction and venue in any court action between the parties, as having been entered into and consummated in the City of Novi, Oakland County, Michigan.
- K. Conflict. In the event of any conflict or inconsistency between the above provisions of this Contract and either or both of the attached Schedules, the provisions in the above text shall govern.

IN WITNESS WHEREOF, the Client and the Contractor have executed this Contract in Oakland County, Michigan, as of the date first listed above.

WITNESS AND DATES
OF SIGNATURES:

CITY OF NOVI

Date: _____

By: Robert J. Gatt
Its: Mayor

Date: _____

By: Maryanne Cornelius
Its: Clerk

WITNESS AND DATES
OF SIGNATURES:

R. C. TUTTLE REFINISHING CO.

Date: _____

By: Robert Sopsich
Its: President



CITY OF NOVI
2015 FALL LANDSCAPE PLANTING
OFFICIAL BID FORM

We, the undersigned as bidder, propose to furnish to the City of Novi according to the specifications, terms, conditions and instructions attached hereto and made a part thereof:

BID #1: Subdivision and Nine Mile Road Tree Plantings

Acceptable species of Plant Material	# of Trees	Source /Phone #	Unit Price (2 Yr. Warranty)	TOTAL
TILIA americana 'Redmond' American Basswood 3" caliper	20	<i>R C Tuttle</i> ALL Trees 2 1/2 - 3 1/2	\$300	\$6,000.00
TILIA cordata 'Greenspire' Greenspire Littleleaf Linden 3" caliper	15	↓	\$300	\$4,500.00
GYMNOCLADUS dioica Kentucky Coffeetree 3" caliper	20		\$300	\$6,000.00
ULMUS americana 'Valley Forge' Valley Forge Elm 3" caliper - spring dug*	20		\$300	\$6,000.00
ACER saccharum 'Green Mountain' Green Mountain Sugar Maple 3" caliper	30		\$300	\$9,000.00
ACER rubrum 'Red Sunset' October Glory Red Maple 3" caliper - spring dug*	5		\$300	\$1,500.00
OSTRYA virginiana Ironwood 2" caliper - spring dug*	5		\$300	\$1,500.00
TOTAL	115			

- If spring dug plants are not available, contact City Landscape Architect for substitutions. If suitable substitutes are not available, some trees may not be planted at this time.

BID #2: Village Wood Lake Park – Meadowbrook Road, Novi, MI 48375

Acceptable species of Plant Material	# of Trees	Source /Phone #	Unit Price (2 Yr. Warranty)	TOTAL
Gymnocladus dioica Kentucky Coffeetree 3" caliper	5	↓	\$ 285	\$ 1,425.00
Acer saccharum 'Commemoration' Sugar Maple 3" caliper	5		\$ 285	\$ 1,425.00
TOTAL	10			\$ 2,850.00

BID #3: Brookfarm Park - Ripple Creek Rd, Novi, MI 48375

Acceptable species of Plant Material	# of Trees	Source /Phone #	Unit Price (2 Yr. Warranty)	TOTAL
Tilia americana 'Redmond' American Basswood 3" caliper	5	↓	\$ 285	\$ 1,425.00
Gymnocladus dioica Kentucky Coffeetree 3" cal	10		\$ 285	\$ 2,850.00
Pinus strobus Eastern White Pine 6-8' height	8		\$ 200	\$ 1,600.00
TOTAL	23			\$ 5,875.00

BID #4: Ella Mae Power Park – 45175 Ten Mile Road, Novi, MI 48375

Acceptable species of Plant Material	# of Trees	Source /Phone #	Unit Price (2 Yr. Warranty)	TOTAL
TILIA americana 'Redmond' American Basswood 3" caliper	3		\$ 270	\$810.00
ACER saccharum 'Commemoration' Commemoration Sugar Maple 3" caliper	12		\$275	\$3,300.00
AMELANCHIER laevis Serviceberry 5-6' clump	2		\$250	\$500.00
CARPINUS caroliniana Musclewood 2" caliper *	3		\$275	\$825.00
OSTRYA virginiana Ironwood 2" caliper*	2		\$275	\$550.00
MALUS 'Snowdrift' Snowdrift Flowering Crabapple 2" caliper	8		\$230	\$1,840.00
TOTAL	30			\$7,825.00

❖ **Must be spring dug – if not available contact city for substitutes. If suitable substitutes are not found, this planting may not occur this fall.**

BID #5: Wildlife Woods Park - 26442 Wixom Rd, Novi, MI 48377

<i>Acceptable species of Plant Material</i>	<i># of Trees</i>	<i>Source /Phone #</i>	<i>Unit Price (2 Yr. Warranty)</i>	<i>TOTAL</i>
ACER saccharum 'Commemoration' Sugar Maple 2.5" caliper	13	↓	\$ 270	\$ 3,510.00
TILIA americana 'Redmond' American Basswood 2.5" cal.	5	✓	\$ 270	\$ 1,350.00
TOTAL	18			\$ 4,860.00

BID #6: Civic Center/Police Station - 45175 Ten Mile Road, Novi, MI 48375

<i>Acceptable species of Plant Material</i>	<i># of Trees</i>	<i>Source /Phone #</i>	<i>Unit Price (2 Yr. Warranty)</i>	<i>TOTAL</i>
CORNUS alternifolia Pagoda Dogwood 6-7' height, single stem*	1	↓	\$ 270	\$ 270.00
CORNUS sericea 'Farrow' Arctic Fire Red Osier Dogwood 5 gal	20	↓	\$ 85	\$ 1,700.00
CORNUS sericea 'Kelseyi' Kelsey Red Osier Dogwood 5 gal	10	↓	\$ 85	\$ 850.00
TOTAL	31			\$ 2,820.00

- **Spring dug only - if good specimen is not available, do not plant. Contact City Landscape Architect for approval of tree selected.**

BID #7: Gateway Sign Plantings – 15 locations around city – detailed plans available for each site. The locations of each sign are noted on the attached map.

Acceptable species of Plant Material	# of Trees	Source /Phone #	Unit Price (2 Yr. Warranty)	TOTAL
JUNIPERUS chinensis 'Skyrocket' Skyrocket Juniper 5-6' height	18		\$ 120	\$ 2,160.00
JUNIPERUS chinensis 'Skyrocket' Skyrocket Juniper 6-7' height	4		\$ 120	\$ 480.00
AMELANCHIER laevis Serviceberry 5-6' clump	3		\$ 200	\$ 600.00
PENNISETUM alopecuroides Fountain Grass 1 gal	5		\$ 15	\$ 75.00
PENNISETUM alopecuroides 'Hameln' Hameln Fountain Grass 1 gal	4		\$ 15	\$ 60.00
PENNISETUM alopecuroides 'Little Bunny' Dwarf Fountain Grass 1 gal	107		\$ 15	\$ 1,605.00
PANICUM virgatum 'Northwind' Northwind Switchgrass 1 gal	3		\$ 15	\$ 45.00
GERANIUM Gerzat 'Rozanne' Rozanne Geranium 1 gal.	92		\$ 15	\$ 1,380.00
COREOPSIS verticillata 'Zagreb' Zagreb Coreopsis 1 gal.	90		\$ 15	\$ 1,350.00
ROSA sp. Red Single Knockout Rose #3 Cont.	1		\$ 60	\$ 60.00

ORIGINAL

Acceptable species of Plant Material	# of Trees	Source /Phone #	Unit Price (2 Yr. Warranty)	TOTAL
RUDBECKIA fulgida 'Goldsturm' Black-eyed Susan 1 gal	11	↓	\$ 15	\$ 165.00
NARCISSUS bulbs Holland Sensation 6" o.c. spacing	528		\$ 1	\$ 528.00
Double-shredded hardwood mulch – natural color – 3" per bed	65cy		\$ 45	\$ 2,925.00
Transplant 2 trees (see note below)	2			\$ 250.00
TOTAL	867			\$ 11,683

Note: There will also be two tree transplants involved on one of the gateway sites – a 3" crabapple at the site (in the will be dug up and moved to Ella Mae Powers park and a 6" dbh spruce will be moved approximately 8 feet forward to the approximate location of the removed crabapple. No warranty is required.

TOTAL BIDS #1-7 \$ 70,413.00

NOTE: The above plant lists are for the Contractor's information only, and no guarantee is expressed or implied that quantities therein are correct or that the list is complete.

Unit Prices:

Unit prices prevail. The City of Novi Purchasing Department will correct all extension errors.

COMMENTS: We have other trees in stock that can be
used for this job at a reduced price.

We have read & understand Specifications Section 18 & 23 relating to warranty and payment terms.

Yes X No _____

We acknowledge receipt of the following Addenda: 0
(please indicate numbers)

NON-IRAN LINKED BUSINESS

By signing below, I certify and agree on behalf of myself and the company submitting this proposal the following: (1) that I am duly authorized to legally bind the company submitting this proposal; and (2) that the company submitting this proposal is not an "Iran linked business," as that term is defined in Section 2(e) of the Iran Economic Sanctions Act, being Michigan Public Act No. 517 of 2012; and (3) That I and the company submitting this proposal will immediately comply with any further certifications or information submissions requested by the City in this regard.

THIS BID SUBMITTED BY:

Company (Legal Registration) R. C. Tuttle Refinishing Co.

Address 2475 S Hickory Ridge Tr

City Milford State MI Zip 48380

Telephone 248-361-1815 Fax 248-685-9157

Representative's Name (please print) Robert Sapsich

Representative's Title President

Representative's Signature 

E-mail _____

Date 10-1-15

ORIGINAL



CITY OF NOVI
2015 FALL LANDSCAPE PLANTING
CONTRACTOR QUESTIONNAIRE

Firm Name: R. C. Tuttle Refinishing Co.

Address: 2475 S Hickory Ridge Tr.

City: Milford State: MI Zip: 48380

Telephone Number: 248-361-1815 Fax Number: 248-685-9157

Email Address: _____

Firm Established: 1980 Years in Business: 35

Type of Organization: (please circle)

- a. Individual b. Partnership c. Corporation d. Joint Venture e. Other

How many full time employees? _____ How many part time employees? _____

Provide information relative to the experience your company has had working with municipalities. Please provide the names of municipalities where service was provided.

City of Riverview - Judy Batcher 281-4224

City of Novi field Operations - Matt Wiktoraski 248-735-5634

Oakland County - Ryan Dividock 248-858-4071

Provide information relative to the experience and financial capability of your company to carry out the terms of this contract.

Comerica Bank - Brighton - Kathi Witt 810-227-0863

Identify those in your firm who would be responsible, including on-site supervision for this project, and submit copies of their certifications. Include educational background of principals and those who will be working on the project.

Robert Sopsich; Been running tree projects for the last 20 years.

Donald Sopsich

How many clients does your company currently serve with the type of services described?
Provide a list.

Four different Communities

Please provide a list of client references (**minimum of 3**) for projects similar in scope to this project, **other than the City of Novi**. Include name, address, phone number and contact person. Please include any municipalities (or other governmental agencies) that you worked for.

Company Oakland County - Development Services
Address 1200 N Telegraph rd, Pontiac, MI 48341
Phone 248-858-4071 Contact name Ryan Dividock

Company West Bloomfield
Address 4640 Walnut Hill rd, West Bloomfield, MI 48323
Phone 248-640-2756 Contact name chris Frey

Company Farmington Hills
Address 3811 Interchange dr, Farmington Hills, MI 48335
Phone 248-473-1884 Contact name Randy C. Lovett

Please identify which professional organizations your company is a good standing member of:
(please check all that apply)

- International Society of Arboriculture
- Tree Care Industry Association
- Arboricultural Society of Michigan
- Michigan Green Industry Association

Provide an Equipment List that for equipment will be on site and available for use by the crew performing tree planting, including skid loaders, trucks, tractors, trailers, etc. Include additional sheet if necessary.

5 pick-up trucks, 2 Dump Trucks, 7 Trailers, 5 Skid Steer loaders, 2 tractors, 1 Spade truck, 1 backhoe.

Based on your current resources, are you available to plant the quantity of plant material identified within the timeframe allocated? Please explain.

Yes, we can plant 30-40 trees per day.

Provide a description of your company's philosophy relative to tree/shrub planting.

Being a family ~~run~~ run company and licenced nursery grower, we take pride in the quality of our stock and work from seedlings to final acceptance of the customer. We water and fertalize to keep the stock healthy.

THE FOREGOING QUESTIONNAIRE IS A TRUE STATEMENT OF FACTS:

Authorized Company Representative (please print): Robert Sopsich

Representative Signature: 

Date 10-1-15



**NOTICE - CITY OF NOVI
INVITATION FOR BIDS**

2015 FALL LANDSCAPE PLANTING

The City of Novi will receive sealed bids for **2015 Fall Landscape Planting** according to the specifications of the City of Novi.

Sealed bids will be received until **11:00 A.M.** prevailing Eastern Time, **Thursday, October 1, 2015**, at which time proposals will be opened and read. Bids shall be addressed to and delivered to:

CITY OF NOVI
CITY CLERK'S OFFICE
45175 Ten Mile Rd.
Novi, MI 48375-3024

OUTSIDE OF MAILING/FED EX/UPS ENVELOPES MUST BEAR THE NAME OF THE BIDDING FIRM AND MUST BE PLAINLY MARKED:

"2015 FALL LANDSCAPE PLANTING BID"

The City reserves the right to accept any or all alternative proposals and award the contract to other than the lowest bidder, to subdivide the award, to waive any irregularities or informalities or both; to reject any or all proposals; and in general to make the award of the contract in any manner deemed by the City, in its sole discretion, to be in the best interest of the City of Novi.

Sue Morianti
Purchasing Manager

Notice dated: September 17, 2015

NOTICE TO BIDDERS:

The City of Novi officially distributes bid documents through the Michigan Intergovernmental Trade Network (MITN). **Copies of bid documents obtained from any other source are not considered official copies.** The City of Novi cannot guarantee the accuracy of any information not obtained from the MITN website and is not responsible for any errors contained by any information received from alternate sources. Only those vendors who obtain bid documents from the MITN system are guaranteed access to receive addendum information, if such information is issued. If you obtained this document from a source other than the source indicated, it is recommended that you register on the MITN site, www.mitn.info, and obtain an official copy.



CITY OF NOVI
2015 FALL LANDSCAPE PLANTING

INSTRUCTIONS TO BIDDERS

This section is intended to provide interested contractors with sufficient information to enable them to prepare and submit proposals for consideration by the City of Novi.

IMPORTANT DATES

Bid Issue Date	September 17, 2015
Last Date for Questions	September 24, 2015 by 12:00 P.M. Please email questions to: Sue Morianti, Purchasing Manager smorianti@cityofnovi.org
Response Due Date	October 1, 2015 by 11:00 A.M.
Anticipated Award Date	October 12, 2015

PROPOSAL SUBMITTALS

Submitted proposals shall include:

- The completed Bid Form and Contractor Questionnaire

FAILURE TO SUBMIT PRICING ON THE PROPOSAL FORM PROVIDED BY THE CITY OF NOVI MAY CAUSE THE BID TO BE CONSIDERED NON-RESPONSIVE AND INELIGIBLE FOR AWARD.

Provide **two (2)** copies of your proposal, **one (1)** unbound signed and clearly marked as ORIGINAL, and **one (1)** copy of the original proposal, clearly marked as COPY. Original proposal may be clipped but should not be stapled or bound. Copies may be stapled and bound. The original and copies should be identical, excluding the obvious difference in labeling. No other distribution of the proposals will be made by the Contractor. Proposals must be signed by an official authorized to bind the Contractor to its provisions.

TYPE OF CONTRACT

If a contract is executed as a result of the quotation, it stipulates a fixed price for products and services.

CONTRACT AWARD

The contract will be awarded to that responsible, responsive bidder whose bid, conforming to this solicitation will be most advantageous to the City of Novi. Qualifications, experience, references, comparable projects, price, previous experience with vendor/contractor, delivery, and other factors will be considered in the

evaluation process and award of contract. The City reserves the right to accept any or all alternative bids and award the contract to other than the lowest bidder, to waive any irregularities or informalities or both; to reject any or all bids; and in general to make the award of the contract in any manner deemed by the City, in its sole discretion, to be in the best interest of the City of Novi.

After contract award, a summary of total price information for all submissions will be posted on the MITN website at www.mitn.info.

INSURANCE

A certificate of insurance naming the City of Novi as an additional insured must be provided by the successful bidder prior to commencement of work. A current certificate of insurance meeting the requirements in Attachment A is to be provided to the City and remain in force during the entire contract period.

CHANGES TO THE BID/ADDENDA

Should any prospective Bidder be in doubt as to the true meaning of any portion of the ITB, or should the Bidder find any patent ambiguity, inconsistency, or omission therein, the Bidder shall make a written request (via email) for official interpretation or correction. Such request shall be submitted to the staff member indicated above. The individual making the request shall be held responsible for its prompt delivery.

Such interpretation or correction, as well as any additional Bid provisions that the City may decide to include, will be made as an addendum, which will be posted on the MITN website at www.mitn.info. Any addendum issued by the City shall become part of the ITB and subsequent contract and shall be taken into account by each bidder in preparing its bid. Only written addenda are binding. It is the Bidder's responsibility to be sure they have obtained all addenda. Receipt of all addenda must be acknowledged on bid form.

RESPONSE DATE

To be considered, sealed proposals must arrive at the specified location by the specified time. There will be no exceptions to this requirement. The City of Novi shall not be held responsible for lost or misdirected proposals.

Contractors mailing proposals should allow ample time to ensure the timely delivery of their proposals. All proposals must be contained in sealed envelopes marked on the outside with the contractor's name and the name of the bid. Proposals received after the closing date and time will not be accepted or considered. Telegraphic, facsimile, or telephone proposals are not acceptable.

SUBMISSION OF BIDS

Bids must be submitted in a sealed envelope. Outside of mailing envelope must be labeled with name of contractor and name of bid. Failure to do so may result in a premature opening or failure to open such proposal.

To be considered, sealed bids must arrive at the Clerk's Office, on or before the specified time and date. There will be no exceptions to this requirement. Contractors

mailing bids should allow ample time to ensure the timely delivery of their bid. Bids received after the closing date and time will not be accepted or considered. Faxed, emailed, or telephone bids are not acceptable. The City of Novi shall not be held responsible for lost or misdirected bids.

Bids must be clearly prepared and legible and must be signed by an Officer of the submitting Company on the enclosed form. **Bids must show unit pricing, extended pricing and totals if requested.** In case of mistakes in price extension, the unit price shall govern. ANY CHANGES MADE ON BID FORMS MUST BE INITIALED OR YOUR BID MAY BE CONSIDERED NON-RESPONSIVE. Failure to include in the bid all information requested may be cause for rejection of the bid.

A bid may be withdrawn by giving written notice to the Purchasing Manager before the stated due date/closing time. After the stated closing time, the bid may not be withdrawn or canceled for a period of One Hundred and Twenty (120) days from closing time.

No proposal will be accepted from, or contract awarded to any person, firm, or corporation that is in arrears or is in default to the City Novi upon any debt or contract, or that is in default as surety or otherwise, or failed to perform faithfully any previous contract with the City.

FREIGHT/SHIPPING/DELIVERY CHARGES

Proposal pricing must contain all shipping/handling/delivery charges.

TAX EXEMPTION

It is understood that the City of Novi is a governmental unit, and as such, is exempt from the payment of all Michigan State Sales and Federal Excise taxes. Do not include such taxes in the bid prices. The City will furnish the successful bidder with tax exemption certificates when requested. The City's tax-exempt number is 38-6032551.

TRANSFER OF CONTRACT/SUBCONTRACTING

The successful bidder will be prohibited from assigning, transferring, converting or otherwise disposing of the contract agreement to any other person, company or corporation without the expressed written consent of the City of Novi. Any subcontractor, so approved, shall be bound by the terms and conditions of the contract. The contractor shall be fully liable for all acts and omissions of its subcontractor(s) and shall indemnify the City of Novi for such acts or omissions.

CONTRACT TERMINATION

The City may terminate and/or cancel this contract (or any part thereof) at any time during the term, any renewal, or any extension of this contract, upon thirty days (30) days written notice to the Contractor, for any reason, including convenience without incurring obligation or penalty of any kind. The effective date for termination or cancellation shall be clearly stated in the written notice.

NON-DISCRIMINATION

In the hiring of employees for the performance of work described in this ITB and subsequent contract, neither the contractor, subcontractor, nor any person acting in their behalf shall by reason of religion, race, color, national origin, age, sex, height, weight, handicap, ancestry, place of birth, sexual preference or marital status discriminate against any person qualified to perform the work required in the execution of the contract.

ACCEPTANCE OF PROPOSAL CONTENT

Should a contract ensue, the contents of the proposal of the successful Bidder may become contractual obligations. Failure of a contractor to accept these obligations may result in cancellation of the award.

MATERIAL SUBMITTED

All documents, specifications, and correspondence submitted to the City of Novi become the property of the City of Novi and are subject to disclosure under the provisions of Public Act No. 442 of 1976 known as the "Freedom of Information Act". This Act also provides for the complete disclosure of contracts and attachments hereto. This means that any informational material submitted as part of this RFP is available without redaction to any individual or organization upon request.

INCURRING COSTS

The City of Novi is not liable for any costs incurred by bidders prior to issuance of a contract.

ECONOMY OF PREPARATION

Proposals should be prepared simply and economically, providing a straightforward and concise description of the contractor's ability to meet the requirements of the bid. Emphasis should be on completeness and clarity of content. Included in the response must be a point by point response to the Requirements and other sections of the bid.

DISCLOSURE OF PROPOSAL CONTENT

After contract award, and upon written request, a summary of total price information for all submissions will be furnished to those contractors participating in this bid.

INDEPENDENT PRICE DETERMINATIONS

By submission of a proposal, the proposer certifies, and in case of a joint proposal, each party hereto certifies as to its own organization, that in connection with the proposal:

- (a) The prices in the proposal have been arrived at independently without consultation, communication, or agreement, for the purpose of restricting competition, as to any matter relating to such prices with any other proposer or with any other Competitor; and
- (b) No attempt has been made or will be made by the proposer to induce any other person or firm to submit or not submit a proposal for the purpose of restricting competition.

Each person signing the proposal certifies that:

- (c) He is the person in the proposer's organization responsible within that organization for the decision as to prices being proposed in the proposal and that he has not participated and will not participate in any action contrary to (a) and (b) above; or
- (d) He is not the person in the proposer's organization responsible within that organization for the decision as to prices being proposed in the proposal but that he has been authorized in writing to act as agent for the persons responsible for such decisions in verifying that such persons have not participated, and will not participate, in any action contrary to (a) and (b) above, and that as their agent, does hereby so certify; and that he has not participated, and will not participate in any action contrary to (a) and (b) above.

A proposal will not be considered for award if the sense of the statements required in the proposal has been altered so as to delete or modify the above.



CITY OF NOVI

2015 FALL LANDSCAPE PLANTING

1. Purpose/Scope of Work

The City of Novi is soliciting seven (7) bids for the 2015 Fall landscape plantings. All bids are for the purchase, installation, and 2-year warranty by the bidding contractor.

- **BID 1: Subdivision and 9 Mile Road Tree Plantings**
- **BID 2: Village Wood Lake Park**
- **BID 3: Brookfarm Park**
- **BID 4: Ella Mae Power Park**
- **BID 5: Wildlife Woods Park**
- **BID 6: Civic Center**
- **BID 7: Gateway Sign Plantings**

ALL BIDS SHALL BE SUBMITTED ON SUPPLIED OFFICIAL BID FORM. All bids shall be quoted on a per unit basis. Any bids not so submitted will be disqualified. It is the intent of the City to utilize one contractor; however we reserve the right to enter into more than one contract. If you are unable to provide the specified quantity of plant material, please indicate by changing the number on the bid forms where appropriate. Bids shall include all material, labor, equipment, and warranty costs.

PLEASE NOTE: IT IS POSSIBLE THAT THE CITY MAY INCREASE OR DECREASE THE NUMBER OF TREES BEING PLANTED. IF THE PROJECT QUANTITIES ARE INCREASED, THE CONTRACTOR WILL HONOR THE UNIT PRICES QUOTED AS A PART OF THIS BID.

2. Applicable Specifications and Standards

- A. *Principles and Practice of Planting Trees and Shrubs*. 1997. International Society of Arboriculture, P.O. Box GG, Savoy, IL 61874
- B. *American Standard for Nursery Stock*. 1996. American Association of Nurserymen, Inc., 1250 I Street, N.C Suite 500, Washington, D.C. 20005

- C. *Standardized Plant Names*. 1942. American Joint Committee on Horticulture Nomenclature, Horace McFarland Company, Harrisburg, Pennsylvania. (Second Edition)
- D. *City of Novi Landscape Design Manual*. 2003. City Council, 45175 W. Ten Mile Road, Novi, MI 48375

3. Planting/Project Season

- A. This project shall be completed within the following dates:

All Bids: October 13, 2015 to November 14, 2015

- B. Variance: If special conditions exist that warrant a variance in the above planting dates, a written request shall be submitted to Parks and Forestry Asset Manager and/or City Landscape Architect stating the special conditions and the proposed variance. The variance will be granted if warranted in the opinion of the Parks and Forestry Asset Manager or City Landscape Architect.

4. General Specifications

- A. Permissible working hours are 7:30 A.M. to 5:00 P.M., Monday through Saturday unless otherwise authorized by the City. The Contractor shall notify the City of intended operations prior to commencement of work on each working day. No weekend or holiday work will be permitted unless prior authorization is granted by the City. At the end of each working day, the contractor shall clean all work sites of all rubbish, debris, and trimmings resulting from the work, and all work locations shall be left in a neat, safe, and presentable condition.
- B. Planting shall commence no later than ten (10) days after the contract has been awarded. Failure to comply may result in termination of this contract.
- C. Contractor shall be responsible for any damage to utilities during the planting process.
- D. Contractor shall be responsible for all associated fees that may be required for this project (Road Commission for Oakland County permit fees, MDOT permit fees, bonds...).
- E. Contractor's employees shall maintain a neat and clean appearance at all times. Employees shall wear the appropriate clothing apparel at all times. All work shall be performed in a professional and courteous manner.
- F. All vehicles performing work on this project shall be properly placarded with the Contractor's name identified. Contractor's equipment shall have neat and clean appearance at all times.
- G. All crews shall be supervised at all times by the Contractor.
- H. Contractor's equipment and general safety practices must meet all OSHA and MIOSHA requirements.
- I. At no time shall the contractor leave open planting holes unfilled with either soil or plant material at the end of the work day. All rubbish, debris, excess soil, sod, trimmings, etc., generated in the performance of this contract shall be properly disposed of off-site by the contractor. All work shall be subject to the direct supervision of the Forestry Division and/or Community Development Department, and

in all respects shall meet with the City's approval as conforming with the provisions and requirement of this contract.

- J. During the progress of work, adequate provisions shall be made by the contractor to accommodate normal traffic flow over the public streets so as to cause a minimum of inconvenience to the general public. Means of ingress and egress for occupants of property adjacent to the work, with convenient access to driveways, housing, or building shall be provided to the maximum possible extent.
- K. The contractor will be required to provide and maintain any and all safety devices, such as barriers, guards, and lights, when and where it may be necessary to do as a result of the work being done. Such devices, barriers, markings, signs, or traffic lights shall conform to the current Michigan Manual of Uniform Traffic Control Devices.
- L. The contractor will be held responsible for the preservation of all public and private property along and adjacent to the work area, and will be required to exercise due care to avoid and prevent any damage or injury as a consequence of his work. All turf, trees, shrubs, ground covers, fences, irrigations systems and utilities shall be adequately protected.
- M. Should any direct or indirect damage or injury result to any public or private property by or on account of any act, omission, neglect, or conduct in the execution of the work or as a consequence of the execution or non-execution thereof on the parts of the Contractor such as property shall be restored, by and at the expense of the Contractor, to a condition equivalent to that existing before the damage or injury occurred, by repairing or rebuilding the same or by otherwise making good such damage or injury in a manner acceptable to the City.
- N. Public Relations: For all street tree plantings an informational door hanger will be distributed by the City to adjacent property owners prior to commencement of the project.
- O. All work must be completed to the satisfaction of the Parks and Forestry Asset Manager, the City Landscape Architect, or his/her representative and any questions as to proper procedures or quality of workmanship will be resolved by the same. The Contractor shall be required to address all City requests as they pertain to this contract. Failure to immediately and appropriately address such issues as determined by the City may result in termination of this contract. A City Representative will inspect the work performed by the contractor to ensure the completion of the planting in accordance with these specifications. Should more than two inspections be required on plant material and/or landscape beds needing additional work, the contractor may be billed for City staff time.
- P. The City and Contractor shall meet at least once a week to discuss the results of the City's inspection/progress reports. Failure to immediately and appropriately address such issues may result in termination of this contract.

5. Planting Locations

- A. The Contractor shall plant at locations to be determined and marked by the Parks and Forestry Asset Manager, City Landscape Architect, or their designee.
- B. The Parks and Forestry Asset Manager and/or City Landscape Architect will supply locations for individual trees/shrubs. The location may be inferred from reference to some identifiable field object or from some line that can be constructed in the field.
- C. No tree shall be planted within 15 lateral feet of overhead utility wires.

- D. No tree shall be planted within 10 ft. of fire hydrants, driveways, streetlights and 35 ft. of intersections, or as specified by local ordinance.
- E. No tree/shrub shall be planted closer than 6' to adjacent curb or road edge unless directed by the City.

6. Utility Verification

- A. **The Contractor shall contact Miss-Dig for verification of the location of all underground utilities in the area of the work and the Contractor shall not commence digging until all underground utilities have been marked.** The Contractor shall be responsible for all damage resulting from neglect or failure to comply with this requirement and/or for all damages to marked underground utilities.

7. Materials

- A. Topsoil will be furnished by the contractor to the site. The topsoil shall be declared by the Contractor to be free from subsoil, roots, stones over 1 inch in (2.5 cm) in diameter, herbicides, contaminants, and other extraneous materials. The Contractor shall dispose of all excavated materials. Topsoil shall be of granular structure, less than 27 percent clay, and 4 to 5 percent organic matter by weight. Topsoil shall not be used in a frozen or muddy condition. The Contractor shall remove all surplus materials.
- B. Compost shall consist of finely divided or granular texture composed of decomposed organic materials.
- C. Mulch: Unless otherwise noted, all mulch shall be Grade A, true 100 percent double-shredded product. It shall be of natural-colored hardwood (either Maple or Oak) with no more than 10% by-product. Wood-chips and sticks are not acceptable.
- D. Substitutions: When a contractor submits their bid, it is assumed they know where to obtain all specified plant materials. Other plant materials of similar characteristics may be accepted with written permission of the City. Proof must be submitted that material specified is not obtainable.
- E. Plants shall be true to species, variety specified, and nursery grown in accordance with good horticultural practices under climatic conditions similar to those in the locality of the project for at least 2 years. Plants of a northern seed source may be used if approved by the Parks and Forestry Asset Manager and/or Landscape Architect. They shall have been freshly dug (during the most recent favorable harvest season) unless otherwise specified in this request for bid.

Unless specifically noted, all plants shall be of specimen quality, exceptionally heavy, symmetrical, so trained or favored in development and appearance to be unquestionably and outstandingly superior in form, compactness, and symmetry. They shall be sound, healthy, vigorous, well branched and densely foliated when in leaf; free of disease and insects, eggs, or larvae; and shall have healthy, well-developed root systems. They shall be free from physical damage or other conditions that would prevent vigorous growth.

Trees with multiple leaders, unless specified, will be rejected. Plant material with a damaged or crooked leader, bark abrasions, sunscald, disfiguring knots, insect damage, or cuts of limbs over $\frac{3}{4}$ in (2cm) in diameter that are not completely closed will be rejected.

Plants shall conform to the measurements specified, except that plants larger than those specified might be used if approved by the Parks and Forestry Asset Manager and/or Landscape Architect. Use of larger plants shall not increase the contract price. If larger plants are approved, the root ball shall be increased in proportion to the size of the plant as specified in the *Principles and Practice of Planting Trees and Shrubs*.

Caliper measurements shall be taken on the trunk 6 inches (15cm) above the natural ground line for trees up to and including 4 inches (10 cm) in caliper, and 12 inches (30 cm) above the natural ground line for trees over 4 inches (10 cm) in caliper. Height and spread dimensions specified refer to the main body of the plant and not from branch tip to branch tip. No "whips" shall be planted. Plants shall be measured when branches are in their position. If a range of a size is given, no plant shall be less than the minimum size, and no less than 50 percent of the plants shall be as large as the maximum size specified. Measurements specified are minimum size acceptable after pruning, where pruning is required. Plants that meet measurements but do not possess a standard relationship between height and spread, according to the American Standards for Nursery Stock, shall be rejected.

- F. The plant list at the end of this section is for the Contractor's information only, no guarantee is expressed or implied that quantities therein are correct or that the list is complete. The Contractor shall satisfy himself that all plant materials shown on the drawings are included in his bid.
- G. All plants shall be labeled by plant name and size. Labels shall be attached securely to all plants, bundles, and containers of plant materials when delivered. Plant labels shall be durable and legible, with information given in weather-resistant ink or embossed process lettering.
- H. **Certificates of Plant Inspections:** Certificates of inspection shall accompany invoices for each shipment of plants as may be required by law for transportation. Certificates are to be filed with the Parks and Forestry Asset Manager and/or City Landscape Architect prior to acceptance of the material. Passing inspection by federal or state governments at place of growth does not preclude rejection of plants at the work site.

8. Selection and Tagging

- A. Plants shall be subject to inspection for conformity to specification requirements and approval by the Parks and Forestry Asset Manager and/or City Landscape Architect prior to delivery. The Parks and Forestry Asset Manager and/or City Landscape Architect shall tag all plant material to be used for this project and reject any plant material that they feel does not meet quality standards. Such approval shall not impair the right of inspection and rejection during progress of the work. A Contractor's representative shall be present at all inspections.
- B. Plants shall be subject to inspection and approval by the Parks and Forestry Asset Manager and/or City Landscape Architect (at their discretion) at their place of growth. Travel expenses (maximum \$800 per staff member) related to inspections will be billed directly to the contractor.

9. Excavation of Planted Areas

- A. Locations for plants and outlines of area to be planted will be identified via marking paint or flagging at the site by the City. Approval of the Parks and Forestry Asset Manager and/or City Landscape Architect may be required before excavation begins.
- B. Detrimental soil conditions: The Parks and Forestry Asset Manager and/or City Landscape Architect are to be notified, in writing, of soil conditions that the Contractor considers detrimental to the growth of plant material. These conditions are to be described as well as suggestions for correcting them. Proper water drainage shall be assured.
- C. Contractor shall repair any broken sprinkler within 24 hours of any damage. Contractor will carry ten (10) couplers and twenty (20) hose clamps and five (5) feet of $\frac{3}{4}$ and 1-inch pipe at all times.
- D. Contractor shall restore, to satisfaction of the Parks and Forestry Asset Manager and/or City Landscape Architect, any damage done to adjacent planting site areas.
- E. Obstructions: if rock, underground construction work, tree roots, or obstructions are encountered in the excavation of plant pits, the Parks and Forestry Asset Manager and/or City Landscape Architect may select alternate locations. Where locations cannot be changed as determined by the Parks and Forestry Asset Manager and/or City Landscape Architect, and where digging is permitted, submit cost required to remove the obstruction to a depth of not less than 6 inches (15 cm) below the required hole depth. Proceed with work after approval of the Parks and Forestry Asset Manager and/or City Landscape Architect.

10. Digging and Handling Plant Materials

- A. Anti-transpirants are to be applied to plants in full leaf immediately before digging. A film shall adequately cover all foliage.
- B. Plant materials designated as B & B shall be properly dug with firm natural balls of soil retaining as many fibrous roots as possible in sizes and shapes as specified in the most recent edition of the *American Standard for Nursery Stock*. Balls shall be firmly wrapped with nonsynthetic, rotatable burlap and secured with nails and heavy, nonsynthetic, and rotatable twine. Root collar will be apparent at surface of ball. No plant material with loose, broken, or manufactured balls will be planted, **except with special written approval before planting.**
- C. Plants grown in containers shall be of appropriate size for the container as specified in the most recent edition of the *American Standard for Nursery Stock*, and be free of circling roots on the exterior and the interior of the root ball.
- D. All other types of nursery stock shall also conform to the *American Standard for Nursery Stock*.

11. Transportation and Storage of Plant Material

- A. Fresh dug material is given preference over plant material held in storage. Plant material held in storage will be rejected if excessive growth or dieback of branches has occurred in storage.
- B. Branches shall be tied with rope or twine only, and in such a manner that no damage will occur to the bark or branches.

- C. During transportation of plant material, the Contractor shall exercise care to prevent injury and drying out of the plant material. Should the roots be dried out, large branches broken, balls of earth broken or loosened, or area of bark torn, the Parks and Forestry Asset Manager and/or City Landscape Architect may reject the injured tree(s) and order them replaced at no additional cost to the City.
- D. Plants must be protected at all times from sun or drying winds. Those plants that cannot be planted immediately on delivery shall be kept in the shade, well protected with soil covered with wet wood chips or other acceptable material and kept well watered. Plants shall not remain unplanted any longer than 3 days after delivery. Plants shall not be bound with wire or rope at any time so as to damage the bark or break branches. Plants shall be lifted and handled with suitable support of the soil ball to avoid damaging it.
- E. All trees shall be transplanted and transported with stem guards. Trees with damaged stems will be rejected
- F. The City will not provide a location for staging of trees or other materials. The City will not provide a location to dump spoils.

12. Planting Operations

- A. All trees/shrub shall be planted in accordance with the tree/shrub planting detail provided.
- B. Width of the planting hole shall be at least 2 – 3 times the width of the rootball. Plants must be set plumb and braced in position until prepared topsoil has been placed around the ball and roots. **Trees and shrubs shall be planted so that the flare of the trunk is 2 inches above preexisting grade.** Plants shall be set so that they will be the same depth 1 year later. The trunk of the tree is not to be used as a lever in positioning or moving the tree in the planting hole.

NOTE: Because some nurseries practice tilling around trees, the root flare may be buried several inches deep. In some cases the top of the root ball may be at ground level, but the root flare actually is too deep. Proper planting depth requires the root flare to be at or slightly above the finished grade. It is important to determine how deep the root flare is in the ball before it is placed in the planting hole. Sometimes the top of the ball may need to be raised until the root flare is at the proper planting depth. Remove the excess soil on the top of the root ball.

- C. Ropes, strings, and wrapping from the top of the root ball are to be removed after the plant has been set. All waterproof or water repellent wrapping shall be removed from the ball. **Remove at least the top half of the wire basket before backfilling.**
- D. Amend the backfill soil by adding 5 percent (by weight, 20-35 percent by volume, depending on materials) composted organic matter. **In heavy clay soils (especially in parks, major roads, interchanges, and other non-residential locations) use soil from the site, composted organic matter and sand in equal volumes.**
- E. Basins are to be formed around tree/shrub root ball with a raised ring of soil as indicated on drawing.
- F. Planting areas are to be finish graded to conform to grades (2-3 inches above preexisting grade) on drawing after full settlement has occurred.
- G. Prior to installing a tree/shrub in a planting hole, the hole shall be filled to 1/2 its depth with water. Water shall remain in the hole until the tree has been backfilled. The

Parks and Forestry Asset Manager and/or City Landscape Architect may allow plant material to be thoroughly watered immediately after planting.

- H. Any excess soil, debris, or trimmings shall be removed from the planting site immediately upon completion of each planting operation.
- I. Planting pits shall be at least 24" greater in diameter than the corresponding root ball, and shall have sides fractured in order to facilitate root penetration. Walls of the planting hole shall be dug so that they are properly sloped and sufficiently loosened to remove the glazing effects of digging. Holes shall be ground only on the day the tree is planted. Contractor is responsible to ensure all holes are safe until planted and covered with mulch.

13. Guying, Staking, Wrapping, Pruning, Mulching, and Stump Removal

- A. All trees shall be staked as identified in the attached planting detail. The contractor shall remove stakes after the first growing season. **NO METAL T-STAKES ARE PERMITTED!**
- B. Staking materials: No wire shall be used around any of the trunks of the trees. Diagonal supporting stakes three (3) shall be sound, uniform oak, redwood, or cedar as identified in the provided planting detail.
- C. **Top half of wire baskets shall be removed (after trees have secured in their plantings holes), taken off not folded under**, after base of the root ball has been secured. This shall include binding twine, wire loops, and first row of wire squares
- D. No tree wrap shall be used unless approved by the Parks and Forestry Asset Manager and/or City Landscape Architect.
- E. Plants are to be pruned at the time of planting and according to best horticulture practice. Pruning of all plant material will include the removal of injured branches, double leaders, waterspouts, suckers, and interfering limbs. Healthy lower branches and small twigs close to the center should not be removed, except as necessary to clear sidewalks or streets. All pruning cuts shall be clean and smooth, with the bark intact and uninjured at the edges. In no case shall more than one-third of the branching structure be removed, **leaving the normal shape of the plant intact**. If use of tree paint is specified by the Parks and Forestry Asset Manager and/or City Landscape Architect, it shall be a standard type specifically recommended as tree wound dressing paint.
- F. All trees/shrubs will be mulched with a mixture of shredded wood and bark previously approved by the Parks and Forestry Asset Manager and/or Landscape Architect. The composted mulch will be free of materials injurious to plant growth, branches, leaves, roots, and other extraneous matter. The mulch will be 4 inches deep around trees and shrubs. **NO WOODCHIPS SHALL BE USED ON THIS PROJECT. Mulch must not be placed within 3 inches (8cm) of the trunks of trees/shrubs.**
- G. The contractor shall dispose of any debris (including tree roots, stumps, rocks, soil...) from the planting area.

14. Maintenance of Plant Materials and Landscape Beds

- A. Maintenance shall begin immediately after each plant is planted and shall continue throughout the period of this contract.
- B. Maintenance shall include ALL landscape beds created through this contract.
- C. Maintenance shall consist of pruning, watering, fertilization, cultivating (including weeding), mulching, edging, tightening and repairing guys and stakes, resetting plants to proper grades or upright position, restoration of the planting saucer, and

furnishing and applying such sprays or other materials as are necessary to keep plantings free of insects and diseases and in vigorous condition.

- D. Planting areas (including landscape beds) and plants shall be protected at all times against damage for the duration of the maintenance period. If a plant becomes damaged or injured, it shall be treated or replaced as directed by the Parks and Forestry Asset Manager and/or City Landscape Architect at no additional cost.
- E. Watering: Contractor shall irrigate, as required, to maintain vigorous and healthy tree growth. **All plants shall be watered at the time of planting unless directed otherwise by the Parks and Forestry Asset Manager and/or City Landscape Architect.** Over-watering or flooding shall not be allowed. Contractor shall use existing irrigation facilities and furnish any additional material, equipment, or water to ensure adequate irrigation. Contractor may fill up their water tanks at the City of Novi DPS Field Services facility. During periods of restricted water usage, all governmental regulations (permanent and temporary) shall be followed. Should modifications of existing irrigation systems and/or schedules facilitate adherence to these regulations, the Contractor shall notify the owner of the suggested modifications.
- F. Fertilization: Fertilizer shall be applied at the time of planting and shall be a controlled-release type formulated for trees and shrubs, and must be approved by the Parks and Forestry Asset Manager and/or City Landscape Architect. The approved fertilizer shall be used at the rate specified by the manufacturer.

15. Contract Termination

The City shall have the right to terminate a contract or part thereof before the work is completed with thirty (30) days written notice:

A. For Cause:

- The contractor is not complying with the specifications;
- Proper arboricultural techniques are not being followed after written notification by the City;
- The Contractor refuses, neglects, or fails to supply properly trained or skilled personnel, proper equipment, or acceptable plant material;
- The Contractor in the judgment of the City is unnecessarily or willfully delaying the performance and completion of the work;
- Previous unknown circumstances arise making it desirable in the public interest to void the contract;
- The Contractor fails to comply with the terms of this contract;
- The Contractor refuses to proceed with the work when as directed by the City; or
- The Contractor abandons the work.

Any hazardous practice as determined by the City shall be immediately discontinued by the contractor upon receipt of either verbal or written notice to discontinue such practice.

For Convenience:

The City may terminate the agreement, in whole or in part, without showing cause upon giving thirty (30) days written notice to the Contractor. The City shall pay all

reasonable costs incurred by the Client up to the date of notice of termination. The Contractor will not be reimbursed for any anticipatory profits that have not been earned up to the date of notice of termination.

16. Acceptance

The Parks and Forestry Asset Manager and/or City Landscape Architect shall inspect all work for acceptance upon written request for the Contractor. The request shall be received at least 10 calendar days before the anticipated date of inspection.

Acceptance of plant material by the Parks and Forestry Asset Manager and/or City Landscape Architect shall be for general conformance to specified size, character, and quality and shall not relieve the Contractor of responsibility for full conformance to the contract documents, including correct species.

Upon completion and re-inspection of all repairs or renewals necessary in the judgment of the Parks and Forestry Asset Manager and/or City Landscape Architect, the Parks and Forestry Asset Manager and/or City Landscape Architect shall certify in writing that the work has been accepted.

17. Acceptance in Part

Work may be accepted in parts when the Parks and Forestry Asset Manager and/or City Landscape Architect and Contractor deem that practice to be in their mutual interest. The Parks and Forestry Asset Manager and/or City Landscape Architect must give approval in writing to the Contractor verifying that the work is to be completed in parts. Acceptance of work in parts shall not waive any other provision of this contract.

18. Guarantee Period and Replacements

- A. The guarantee period for plant material shall begin at the date of acceptance.
- B. The Contractor shall guarantee all plant material to be in healthy and flourishing condition as determined by the City of Novi for a period of 2 years from the date of acceptance.
- C. When work is accepted in parts, the guarantee periods extend from each of the partial acceptances to the terminal date of the guarantee of the last acceptance. Thus, **all guarantee periods terminate at one time.**
- D. The Contractor shall replace, without cost, as soon as weather conditions permit, and within a specified planting period, all plants determined by the Parks and Forestry Asset Manager and/or City Landscape Architect to be dead or in an unacceptable condition during and at the end of the guarantee period. To be considered acceptable, plants shall be free of dead or dying branches and branch tips and shall bear foliage of normal density, size, and color. Replacements shall closely match adjacent specimens of the same species. Replacements shall be subject to all requirements stated in this specification. The City may allow substitutions.
- E. The guarantee of all replacement plants shall extend for an additional period of 1 year beyond the initial warranty period (one year beyond the initial two year warranty period). If a tree dies between the 1 and two year initial warranty period, the warranty on the replacement tree shall extend for a period 1 year after the 2 year initial warranty period has ended. In the event that a replacement plant is not acceptable during or at

the end of the said extended guarantee period, the Parks and Forestry Asset Manager and/or City Landscape Architect may elect subsequent replacement or credit for that item.

- F. The Contractor shall make periodic inspections, at no extra cost, during the guarantee period to determine what changes, if any, should be made in the maintenance program. If changes are recommended, they shall be submitted in writing to the Parks and Forestry Asset Manager and/or City Landscape Architect.
- G. In the event that any plantings fail, the Contractor will be notified that it must be removed and replaced. If the planting is not removed within a fifteen (15) day period, the City may opt to cut the planting down. The Contractor shall be responsible for the removal of the existing root ball and replacement of any failed planting removed by the City. If a planting is removed outside the growing season, the Contractor shall replace the planting by October 1 of the next growing season.

19. Final Inspection and Final Acceptance

At the end of the guarantee period and upon written request of the Contractor, the Parks and Forestry Asset Manager and/or City Landscape Architect will inspect all guaranteed work for final acceptance. The request shall be received at least 5 days before the anticipated date for final inspection. Upon completion and re-inspection of all repairs or renewals necessary in the judgment of the Parks and Forestry Asset Manager and/or City Landscape Architect at that time, the Parks and Forestry Asset Manager and/or City Landscape Architect shall certify, in writing, that the project has received final acceptance.

20. Selection Criteria

Proposals will be evaluated and ranked. The City of Novi reserves the right to reject any and all proposals, to make an award based directly on the proposals or to negotiate further with one or more companies. The proposer selected for the award will be chosen on the basis of the apparent greatest benefit to the City, including but not limited to:

A. Experience/Qualifications

Proposals on this contract shall be limited to individuals, partnerships, and corporations actively engaged in landscaping. Proposers shall demonstrate competence, experience, and financial capability to carry out the terms of this contract. The City will require proof of these qualifications and work performance references.

B. Capacity

Proposers should clearly identify all available resources within the company and those that will be subcontracted to others. Provide an Equipment List and number of full-time/part-time employees that will be made available to accomplish the work described in these documents.

C. Comparable Projects

Proposers should submit examples of similar work performed.

D. Timeline

Provide proposed schedule for the performance of the tree planting services, including under unusual or unexpected weather conditions.

E. References

Provide a list of references from comparable projects that have been successfully completed by your company. Include the names of contacts.

F. Cost

Cost Proposals per Official Bid Form.

21. General Conditions

- A. The City of Novi reserves the right to interview any number of qualifying providers as part of the evaluation process. The decision of which provider to contact (if any) will be based on the most qualified, cost effective and experienced provider(s) determined in the evaluation process. The City of Novi reserves the right to select, and subsequently recommend for award, the proposed services which best meets its required needs, quality levels and budget constraints.
- B. The City is not required to accept the lowest proposal in all or in part. The proposal award will not be based solely upon cost, but will be evaluated based upon criteria formulated around the most important features of the services, of which qualifications, experience, capacity and comparable projects may be overriding factors. The proposal evaluation criteria should be viewed as standards, which measure how well a vendor's approach meets the desired requirements and needs of the City.
- C. All proposals shall be opened publicly at the date and time specified. Each shall be recorded with the name of the proposer. All proposals shall be in accordance with the Purchasing Department and the requirements of this notice in order to be deemed "responsive."
- D. No proposal will be accepted from any person, firm or corporation who is in arrears upon any obligation to the City or who otherwise may be deemed irresponsible or unreliable by the City.
- E. No proposal will be allowed to be withdrawn after it has been deposited with the City of Novi, except as provided by law.
- F. Any deviation from the scope of work must be noted in the proposal.
- G. The Invitation for Bids document together with its addenda, amendments, attachments and modifications, when executed, becomes the contract or part of the contract between the parties.
- H. Any proposal submitted which requires a down payment or prepayment of any kind prior to work completion and full acceptance as being in conformance to specifications will not be considered for award.

22. Instructions to Contractors

The following pages include a **(1)** vendor questionnaire and **(2)** official bid form. These items must be **FULLY** completed and submitted. Bidders not responding to any of the specifications or questions may be classified as unresponsive. The response must follow the format outlined in this proposal. Supplemental information may be attached.

23. Payment

Payment shall be made to the Contractor as follows:

- 80 % of the contract sum upon receipt, completion of planting of the plant materials by the contractor, and acceptance of the plant materials by the Parks & Forestry Asset Manager and/or City Landscape Architect.
- 10 % of contract sum after the replanting of all necessary replacement material after one year.
- 10 % of contract sum after final acceptance. This would occur after all replacement material warranties are complete and after the completion and acceptance after the two year warranty period.

NOTE: It is the contractor's responsibility to ensure that all invoices are accurate and detailed. Invoices must include the address/location of each tree planted as well as the type of tree planted at each location. Failure to submit accurate and detailed invoices will result in delayed payment.



CITY OF NOVI
INSURANCE REQUIREMENTS

ATTACHMENT A

1. The Contractor shall maintain at its expense during the term of this Contract, the following insurance:
 - A. **Worker's Compensation** insurance with the Michigan statutory limits and Employer's Liability insurance with minimum limits of **\$100,000** (One Hundred Thousand Dollars) each accident.
 - B. **Commercial General Liability Insurance** – The Contractor shall procure and maintain during the life of this contract, Commercial General Liability Insurance, Personal Injury, Bodily Injury and Property Damage on an "Occurrence Basis" with limits of liability not less than **\$1,000,000** (One Million Dollars) per occurrence combined single limit.
 - C. **Automobile Liability** insurance covering all owned, hired and non-owned vehicles with Personal Protection insurance to comply with the provisions of the Michigan No Fault Insurance Law including Residual Liability insurance with minimum bodily injury limits of **\$1,000,000** (One Million Dollars) each person and **\$1,000,000** (One Million Dollars) each occurrence and minimum property damage limits of **\$1,000,000** (One Million Dollars) each occurrence.
2. All policies shall name the Contractor as the insured and shall be accompanied by a commitment from the insurer that such policies shall not be canceled or reduced without at least thirty (30) days prior notice date to the City; alternately; contractor may agree to provide notice of such cancellation or reduction.
3. The City of Novi shall be named as Additional Insured for General Liability and Auto Liability. Certificates of Insurance evidencing such coverage shall be submitted to City of Novi, Purchasing Department, 45175 Ten Mile Road, Novi, Michigan 48375-3024 prior to commencement of performance under this Contract and at least fifteen (15) days prior to the expiration dates of expiring policies. A current certificate of insurance must be on file with the City for the duration of the contract. Said coverage shall be PRIMARY COVERAGE rather than any policies and insurance self-insurance retention owned or maintained by the City. Policies shall be issued by insurers who endorse the policies to reflect that, in the event of payment of any loss or damages, subrogation rights under those contract documents will be waived by the insurer with respect to claims against the City
4. The Contractor shall be responsible for payment of all deductibles contained in any insurance required hereunder.
5. If, during the term of this Contract, changed conditions or other pertinent factors should in the reasonable judgment of the City render inadequate insurance limits, the Contractor will furnish on demand such additional coverage as may reasonably be required under the circumstances. All such insurance shall be effected at the

Contractor's expense, under valid and enforceable policies, issued by the insurers of recognized responsibility which are well-rated by national rating organizations and are acceptable to the City.

6. If any work is sublet in connection with this Contract, the Contractor shall require each subcontractor to effect and maintain at least the same types and limits of insurance as fixed for the Contractor.
7. The provisions requiring the Contractor to carry said insurance shall not be construed in any manner as waiving or restricting the liability of the Contractor under this contract.
8. The City has the authority to vary from the specified limits as deemed necessary.

ADDITIONAL REQUIREMENTS
HOLD HARMLESS/INDEMNITY

1. The Contractor agrees to fully defend, indemnify and hold harmless the City, its City Council, its officers, employees, agents, volunteers and contractors from any claims, demands, losses, obligations, costs, expenses, verdicts, and settlements (including but not limited to attorney fees and interest) resulting from:
 - A. Acts or omissions by the Contractor, its agents, employees, servants and contractors in furtherance of execution of this Agreement, unless resulting from the sole negligence and tort of the City, its officers, employees, agents and contractors.
 - B. Violations of state or federal law involving whether administrative or judicial, arising from the nature and extent of this Agreement.
 - C. The Contractor agrees to defend the City from and against any and all actions or causes of action, claims, demands or whatsoever kind or nature arising from the operations of the Contractor and due to the acts or omissions of the Contractor or its agents, including, but not limited to, acts of omissions alleged to be in the nature of gross negligence or willful misconduct. The Contractor agrees to reimburse the City for reasonable attorney fees and court costs incurred in the defense of any actions, suits, claims or demands arising from the operations of the Contractor under this Agreement due to the above-referenced acts or omissions.
2. The Contractor agrees that it is its responsibility and not the responsibility of the City of safeguard the property and materials used in performing this Contract. Further the Contractor agrees to hold the City harmless for any loss of such property and materials used in pursuant to the Contractor's performance under this Contract.
3. The Contractor shall not discriminate against any employee, or applicant for employment because of religion, race, color, national origin, age, sex, height, weight, handicap, ancestry, place of birth, sexual preference or marital status. The Contractor further covenants that it will comply with the Civil Rights Act of 1973, as amended; and the Michigan Civil Rights Act of 1976 (78. Stat. 252 and 1976 PA 453) and will require a similar covenant on the part of any consultant or subcontractor employed in the performance of this contract

NOTE:

GUY DECIDUOUS TREES ABOVE 3" CAL.. STAKE DECIDUOUS TREES BELOW 3" CAL.

STAKE TREES AT FIRST BRANCH USING BELT-LIKE FABRIC STRAPS. ALLOW FOR SOME MINIMAL FLEXING OF THE TREE. REMOVE AFTER ONE YEAR.

2" X 2" HARDWOOD STAKES, MIN. 36" ABOVE GROUND FOR UPRIGHT, 18" IF ANGLED. DRIVE STAKES A MIN. 18" INTO UNDISTURBED GROUND OUTSIDE ROOTBALL. REMOVE AFTER ONE YEAR.

MULCH 4" DEPTH WITH SHREDDED HARDWOOD BARK. NATURAL IN COLOR. LEAVE 3" CIRCLE OF BARE SOIL AT BASE OF TREE TRUNK.

MOUND EARTH TO FORM SAUCER

REMOVE ALL NON-BIODEGRADABLE MATERIALS COMPLETELY FROM THE ROOTBALL. CUT DOWN WIRE BASKET AND FOLD DOWN BURLAP FROM TOP 1/2 OF THE ROOTBALL.

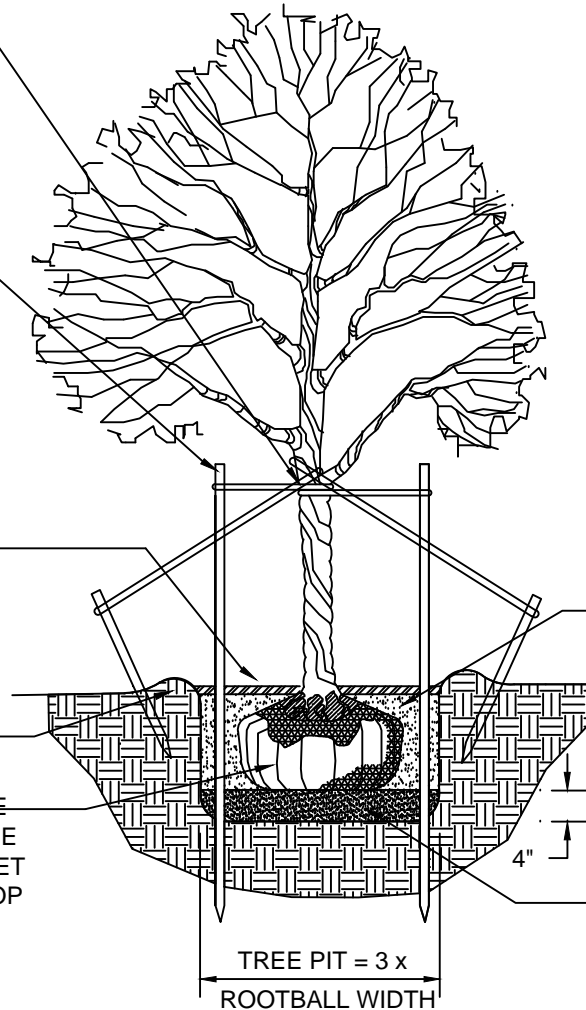

NOTE:

TREE SHALL BEAR SAME RELATION TO FINISH GRADE AS IT BORE ORIGINALLY OR SLIGHTLY HIGHER THAN FINISH GRADE UP TO 6" ABOVE GRADE, IF DIRECTED BY LANDSCAPE ARCHITECT FOR HEAVY CLAY SOIL AREAS.

DO NOT PRUNE TERMINAL LEADER. PRUNE ONLY DEAD OR BROKEN BRANCHES.

REMOVE ALL TAGS, STRING, PLASTICS AND OTHER MATERIALS THAT ARE UNSIGHTLY OR COULD CAUSE GIRDLING.

PLANTING MIXTURE: AMEND SOILS PER SITE CONDITIONS AND REQUIREMENTS OF THE PLANT MATERIAL.

SCARIFY SUBGRADE AND PLANTING PIT SIDES. RECOMPACT BASE OF TO 4" DEPTH.

DECIDUOUS TREE PLANTING DETAIL

NOTE:
GUY EVERGREEN TREES ABOVE 12'
HEIGHT. STAKE EVERGREEN TREE
BELOW 12' HEIGHT

STAKE TREES AT FIRST BRANCH
USING 2"-3" WIDE BELT-LIKE
FABRIC STRAPS. ALLOW FOR SOME
MINIMAL FLEXING OF THE TREE.
REMOVE AFTER ONE YEAR.

2" X 2" HARDWOOD STAKES, MIN.
36" ABOVE GROUND FOR UPRIGHT,
18" IF ANGLED. DRIVE STAKES A
MIN. 18" INTO UNDISTURBED
GROUND OUTSIDE ROOTBALL.
REMOVE AFTER ONE YEAR.

MULCH 4" DEPTH WITH SHREDDED
HARDWOOD BARK. NATURAL IN
COLOR. LEAVE 3" CIRCLE OF BARE
SOIL AT BASE OF TREE TRUNK.

MOUND EARTH TO FORM SAUCER

REMOVE ALL NON-BIODEGRADABLE
MATERIALS COMPLETELY FROM THE
ROOTBALL. CUT DOWN WIRE BASKET
AND FOLD DOWN BURLAP FROM TOP
1/2 OF THE ROOTBALL.

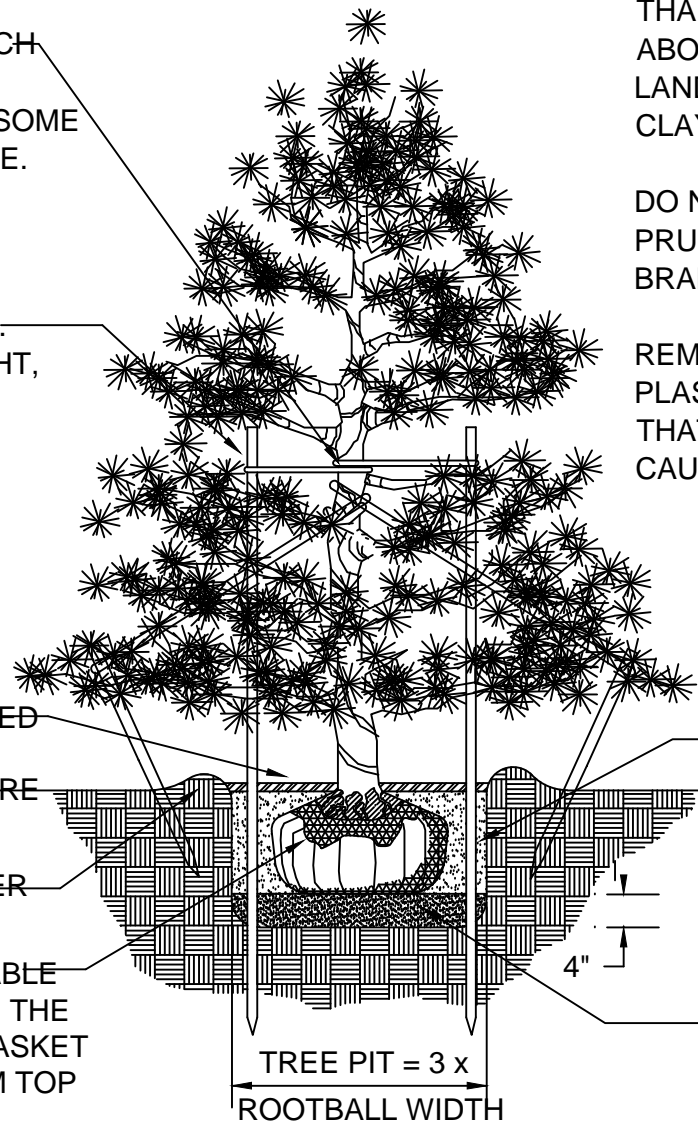

NOTE:
TREE SHALL BEAR SAME RELATION
TO FINISH GRADE AS IT BORE
ORIGINALLY OR SLIGHTLY HIGHER
THAN FINISH GRADE UP TO 6"
ABOVE GRADE, IF DIRECTED BY
LANDSCAPE ARCHITECT FOR HEAVY
CLAY SOIL AREAS.

DO NOT PRUNE TERMINAL LEADER.
PRUNE ONLY DEAD OR BROKEN
BRANCHES.

REMOVE ALL TAGS, STRING,
PLASTICS AND OTHER MATERIALS
THAT ARE UNSIGHTLY OR COULD
CAUSE GIRDLING.

PLANTING MIXTURE:
AMEND SOILS PER SITE
CONDITIONS AND
REQUIREMENTS OF THE
PLANT MATERIAL.

SCARIFY SUBGRADE
AND PLANTING PIT
SIDES. RECOMPACT
BASE OF TO 4" DEPTH.

EVERGREEN TREE PLANTING DETAIL

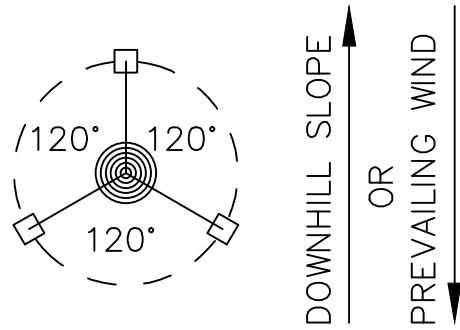

NOTE:

ORIENT STAKING/GUYING TO PREVAILING WINDS, EXCEPT ON SLOPES GREATER THAN 3:1 ORIENT TO SLOPE.

USE SAME STAKING/GUYING ORIENTATION FOR ALL PLANTS WITHIN EACH GROUPING OR AREA

STAKING/GUYING LOCATION

2"-3" WIDE BELT-LIKE FABRIC STRAPS.

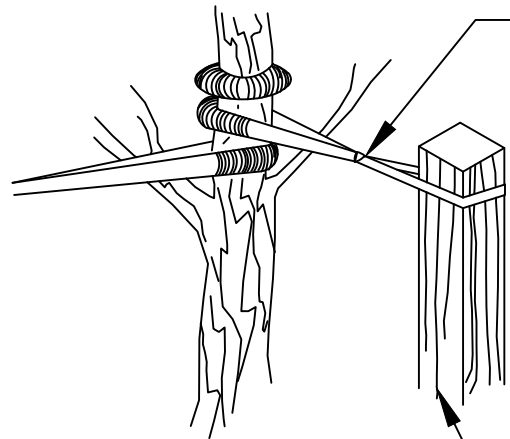
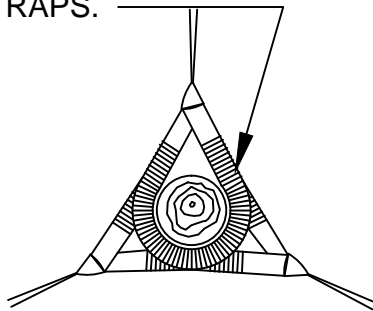

2"-3" WIDE BELT-LIKE FABRIC STRAPS.

STAKES AS SPECIFIED 3 PER TREE

GUYING DETAIL

STAKING DETAIL

TREE STAKING DETAIL

Not to scale

NOTES:

PRUNE AS SPECIFIED
STAKE 3 LARGEST STEMS, IF TREE
HAS MORE THAN 3 LEADERS
SET TREE STAKES VERTICAL AND
AT SAME HEIGHT.

3 STAKES PER TREE MAX.

LACE STRAPS TOGETHER WITH
SINGLE STAY

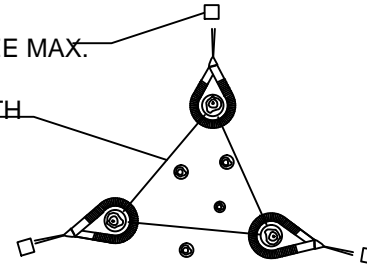

PLAN

MOUND TO FORM SAUCER

4" OF MULCH

REMOVE ALL NON-BIODEGRADABLE
MATERIALS COMPLETELY FROM THE
ROOTBALL. CUT DOWN WIRE BASKET
AND FOLD DOWN BURLAP FROM TOP
 $\frac{1}{3}$ OF THE ROOTBALL.

PLANT MIXTURE AS SPECIFIED

SCARIFY TO 4" DEPTH AND
RECOMPACT

STAKES TO EXTEND 12" BELOW
TREE PIT IN UNDISTURBED
GROUND

SET STAYS ABOVE FIRST
BRANCHES, APPROX. HALFWAY UP
TREE (SEE DETAIL).
FABRIC STRAPS ONLY.

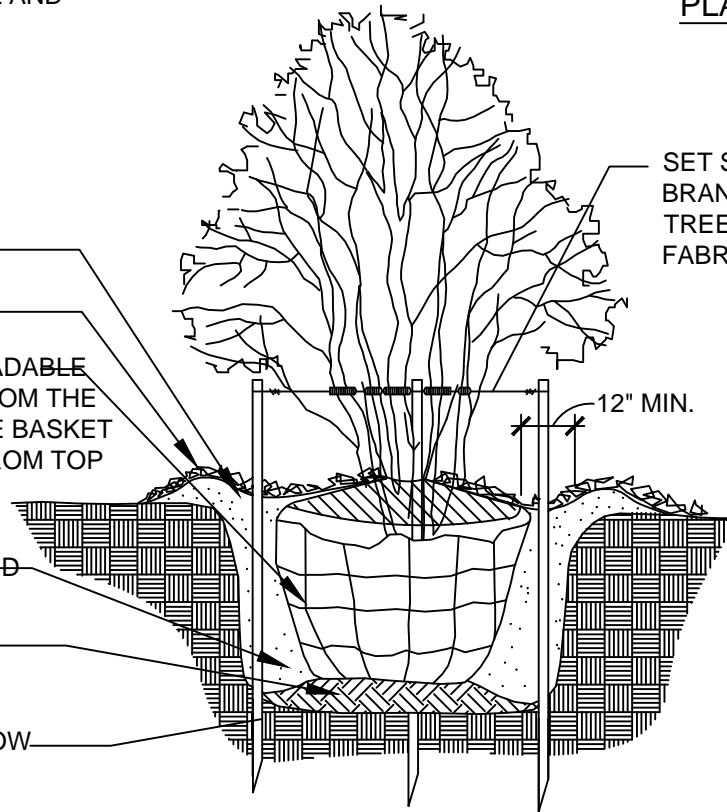

TREE PIT = 3x ROOTBALL WIDTH

MULTI-STEM TREE PLANTING DETAIL

Not to scale



CITY OF NOVI
2015 FALL LANDSCAPE PLANTING
ADDENDUM #1

INTENT: This addendum has been issued to modify and/or interpret the original specifications for the bid (ITB) named above. Unless otherwise instructed, the information contained within this Addendum shall take precedence over anything contrary in the original specifications, and shall hereinafter be considered as part of the package.

RESPONSE: The Contractor shall verify receipt of this Addendum on the Bid Form.

CONTENTS: Included in this Addendum is one (1) page of written addenda description.

CLARIFICATIONS:

1) Bid #6 & 7 will require some transplanting or removal of some materials (to be included in plant pricing, not as a separate pricing item). This list is subject to some minor modifications, if needed.

Bid #6

Civic Center Transplant 6 small rose bushes to locations 25' away
Police Station Remove 1 living shrub

Bid #7 Gateway Signs

8 Mile & Beck Remove 5 dead Skyrocket junipers
8 Mile & Haggerty Remove 1 weak Skyrocket juniper, approximately 9
daylilies
Grand River & Haggerty Remove 2 healthy Arborvitaes, 1 switchgrass
12 Mile & Haggerty Remove 1 weak 7' (height) Skyrocket juniper
13 Mile & Haggerty Remove 3 ornamental grasses
West Park & Pontiac Trail Remove 3 dead 5' (height) Skyrocket junipers
Novi & Grand River NW Remove 9 daylilies
Novi & Grand River SE Remove small buckthorn
Novi & Grand River SE Transplant 3 ornamental grasses to new location at the
same sign

2) **Locations of two trees that require transplanting** (already on Bid #7 bid form as a separate pricing item)

Grand River & Wixom Remove 3" dbh Crabapple and transplant to Civic Center
location
Grand River & Wixom Transplant 8' (height) spruce approximately 10' forward

Sue Morianti, Purchasing Manager

Notice dated: September 22, 2015